

KALEVI 70

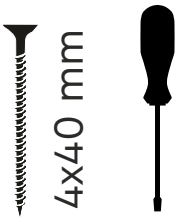

Ø 3 mm



4x40 mm

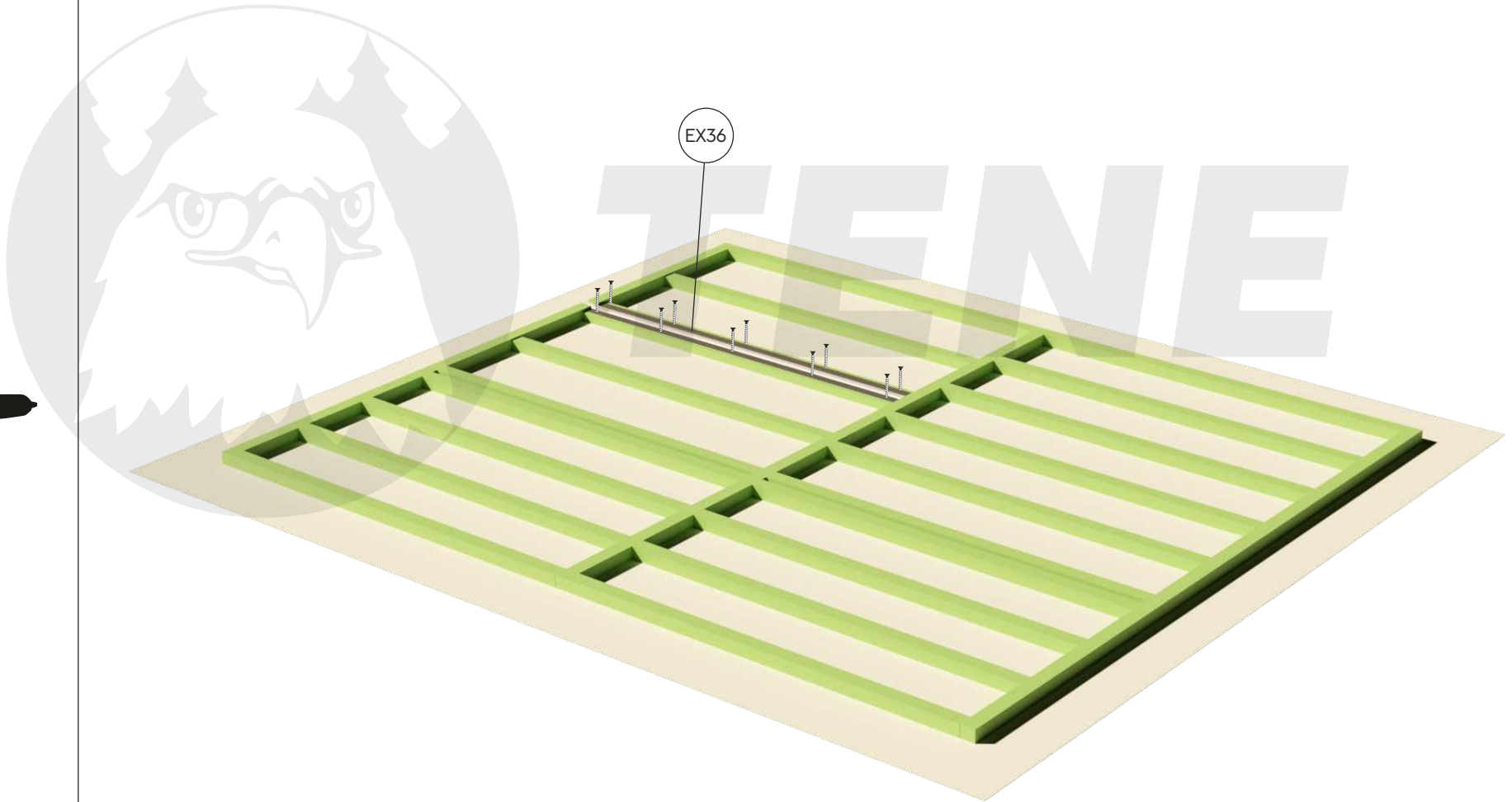

EX36

KALEVI 70

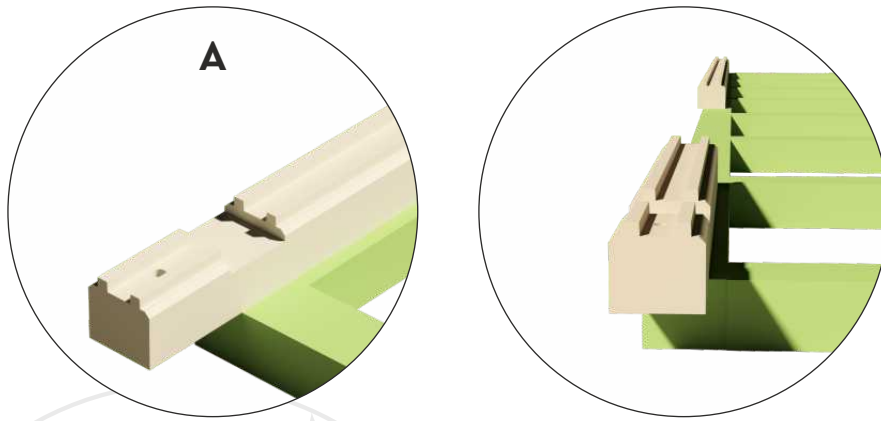

Ø 4 mm

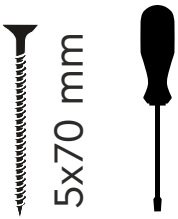

5x70 mm

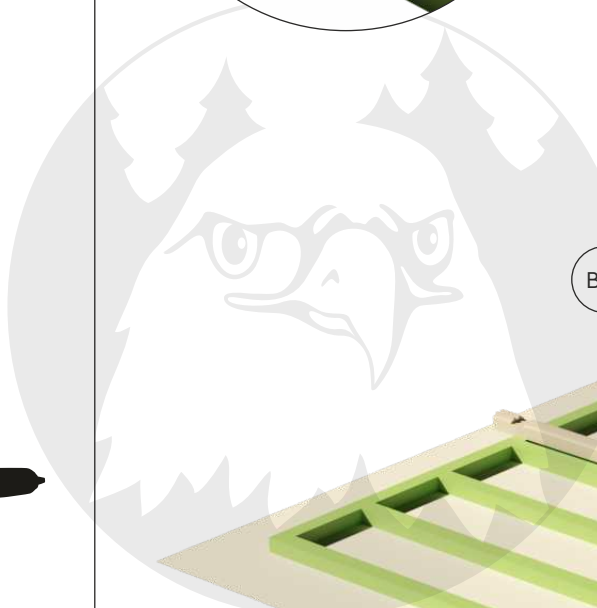
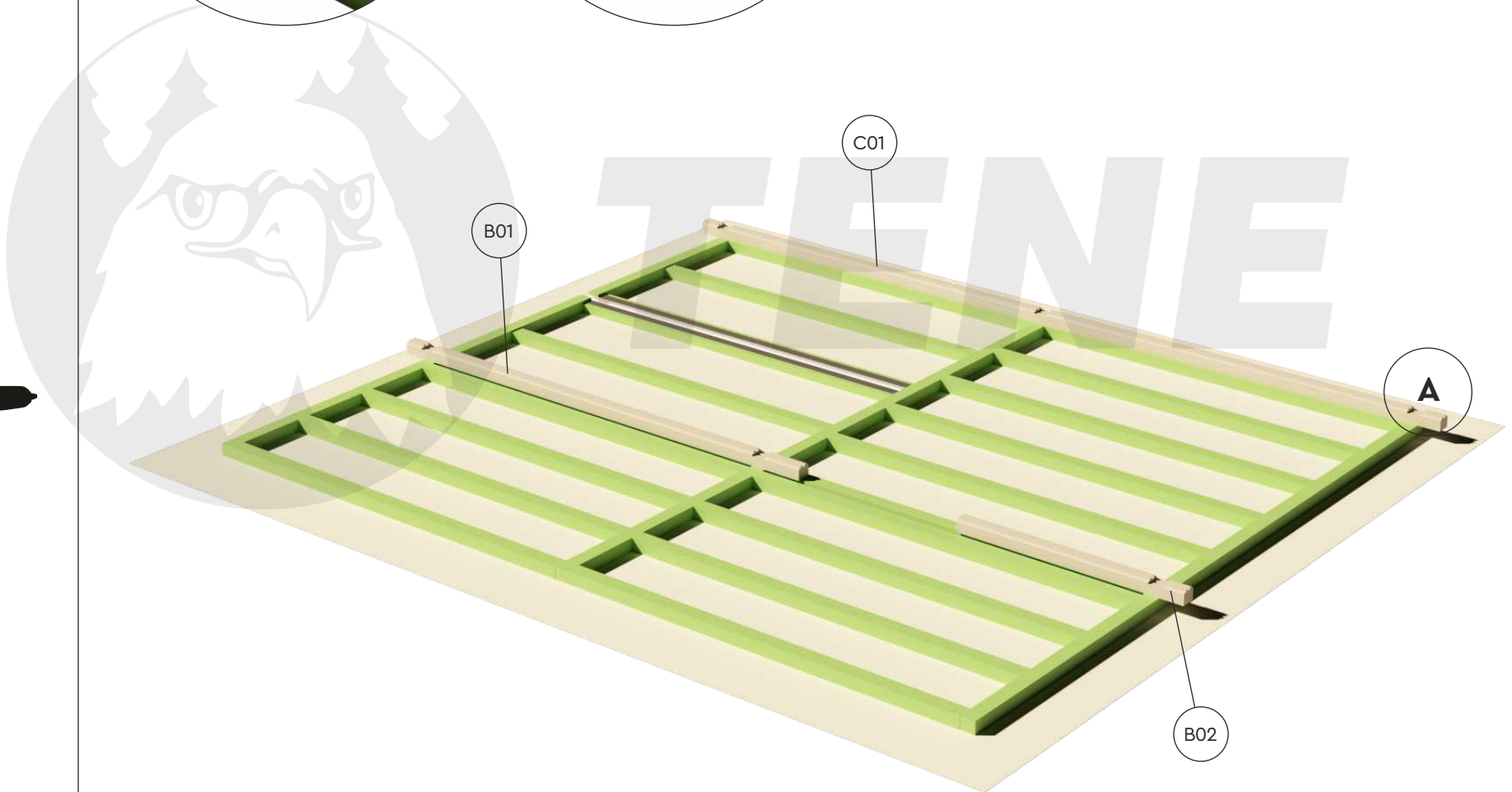

KALEVI 70

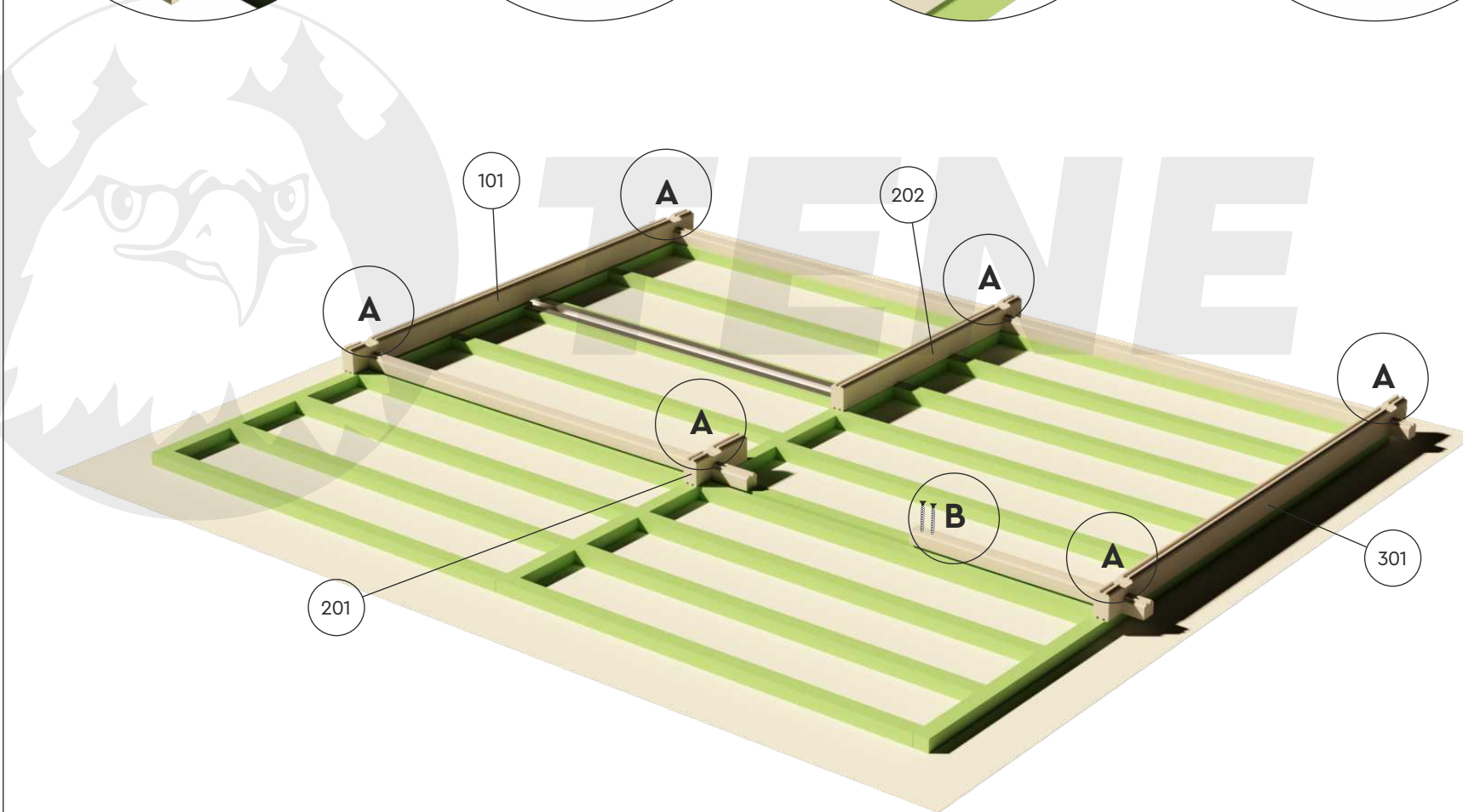
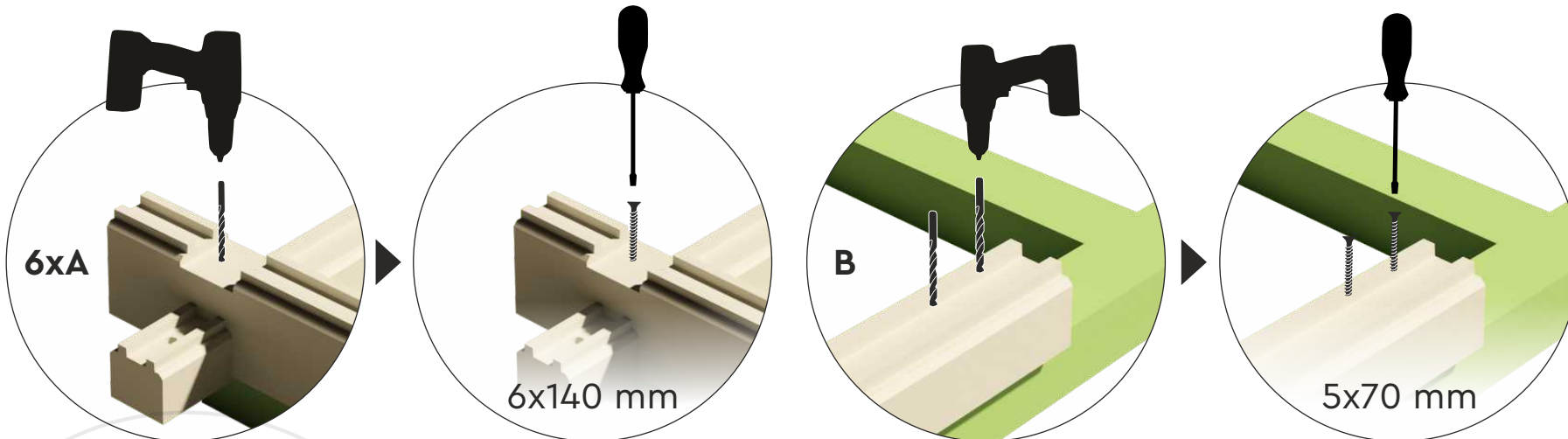

KALEVI 70

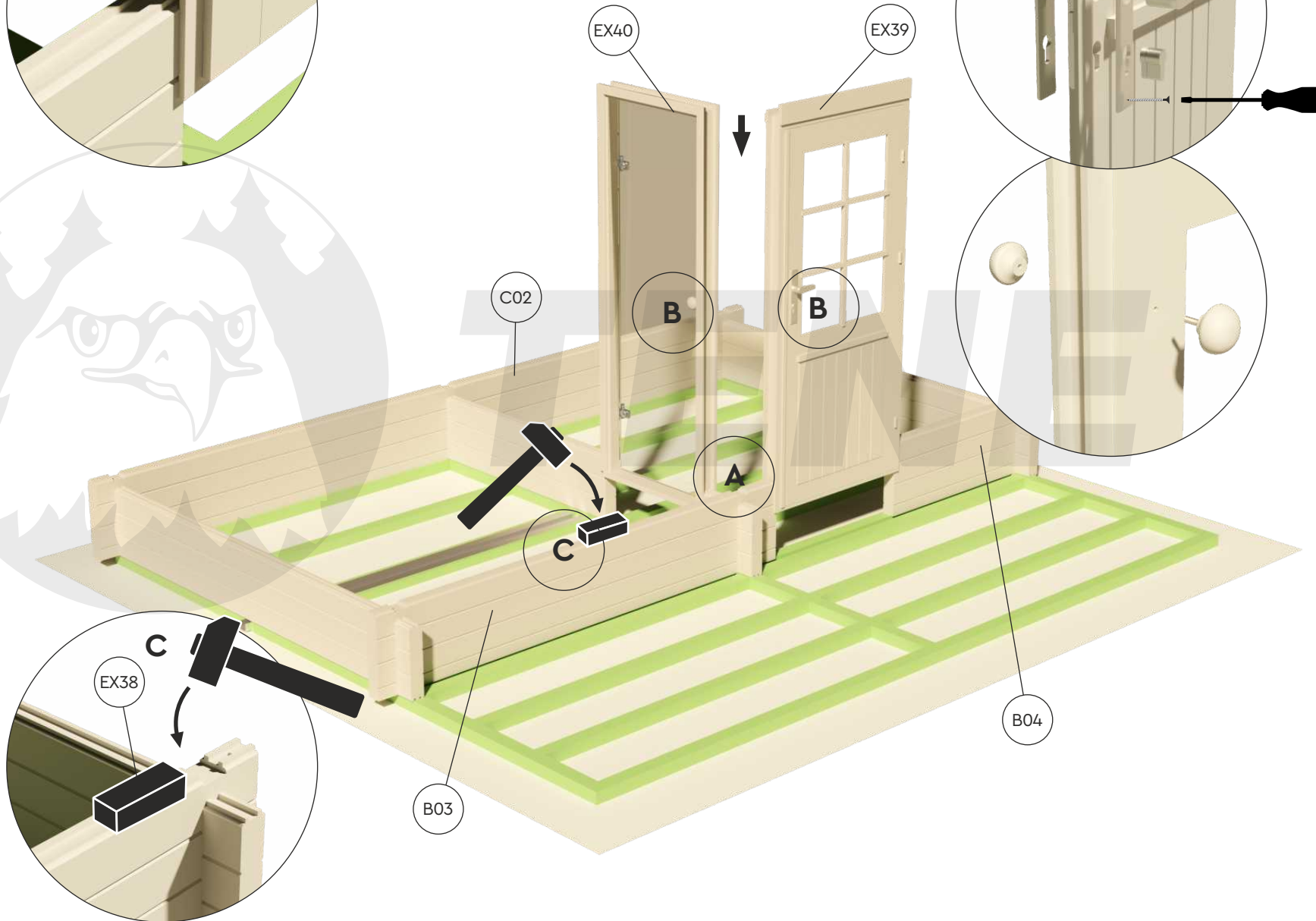
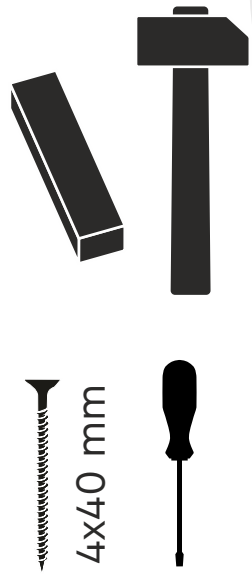
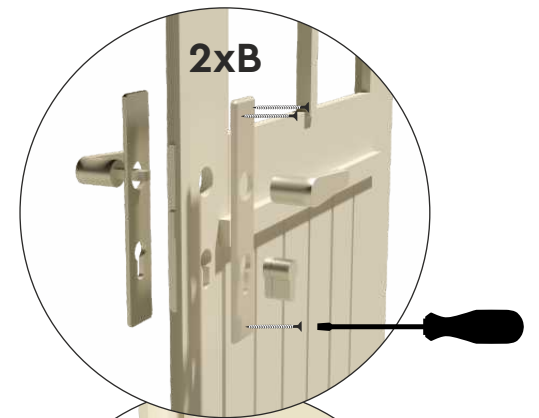
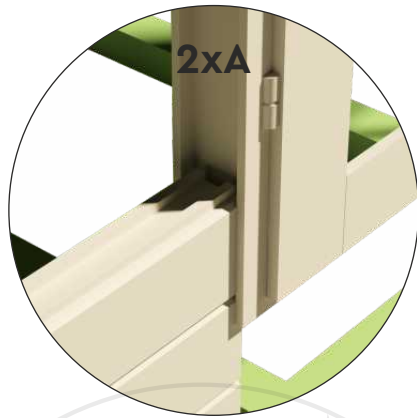

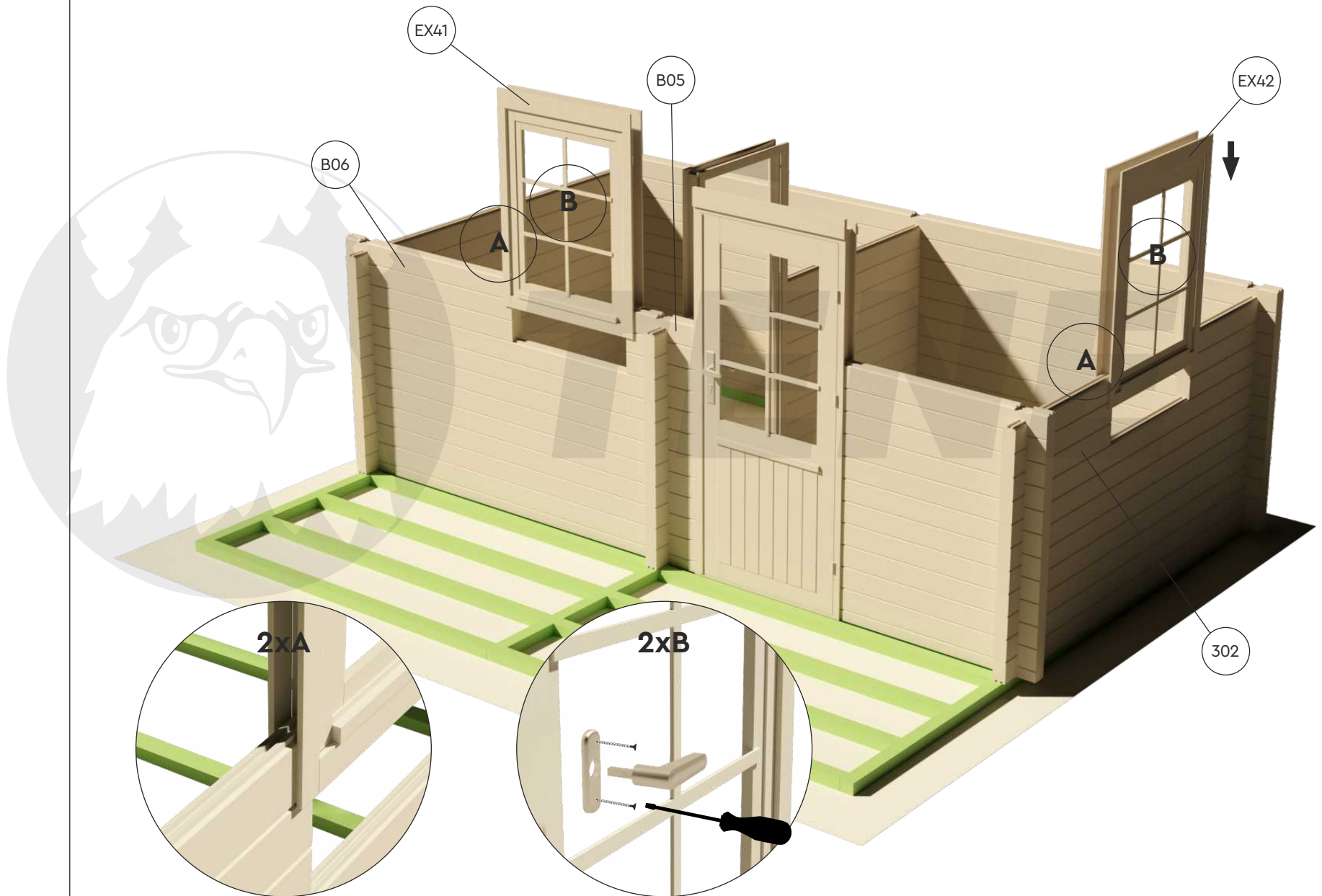

KALEVI 70

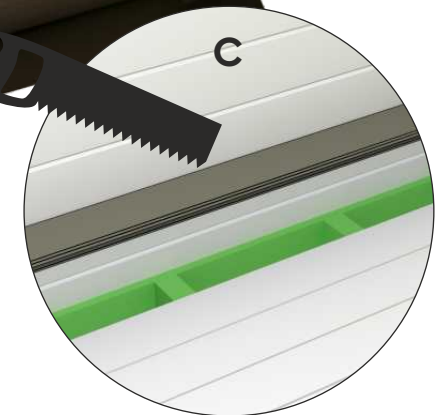
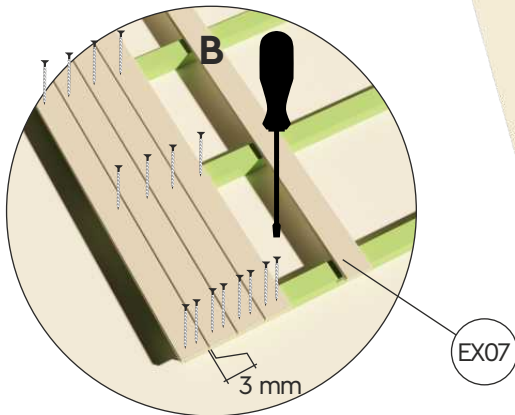
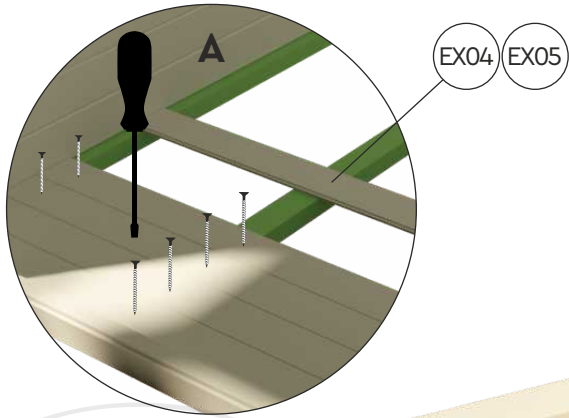

∅ 3 mm



4x50 mm



KALEVI 70

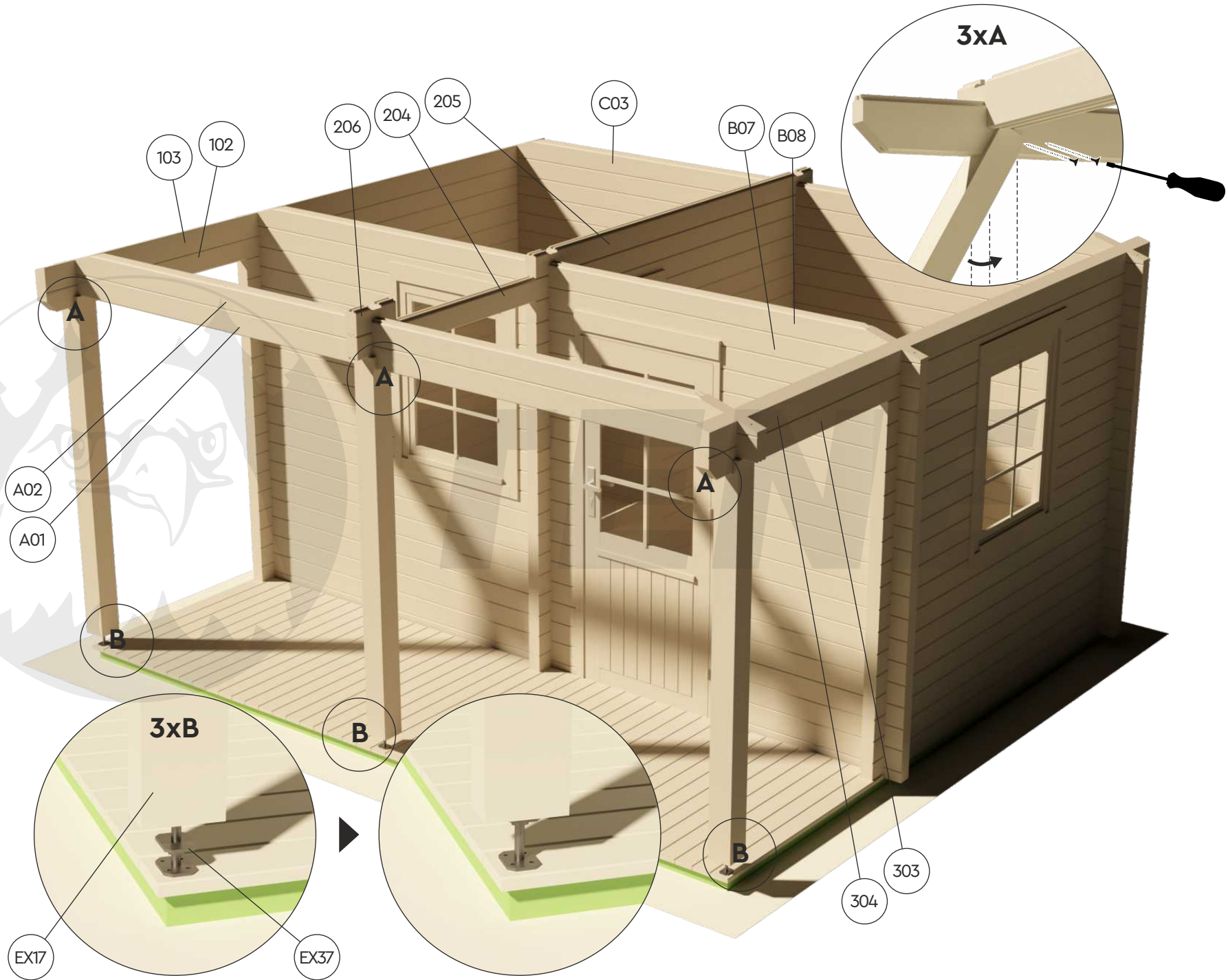

KALEVI 70

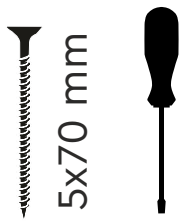
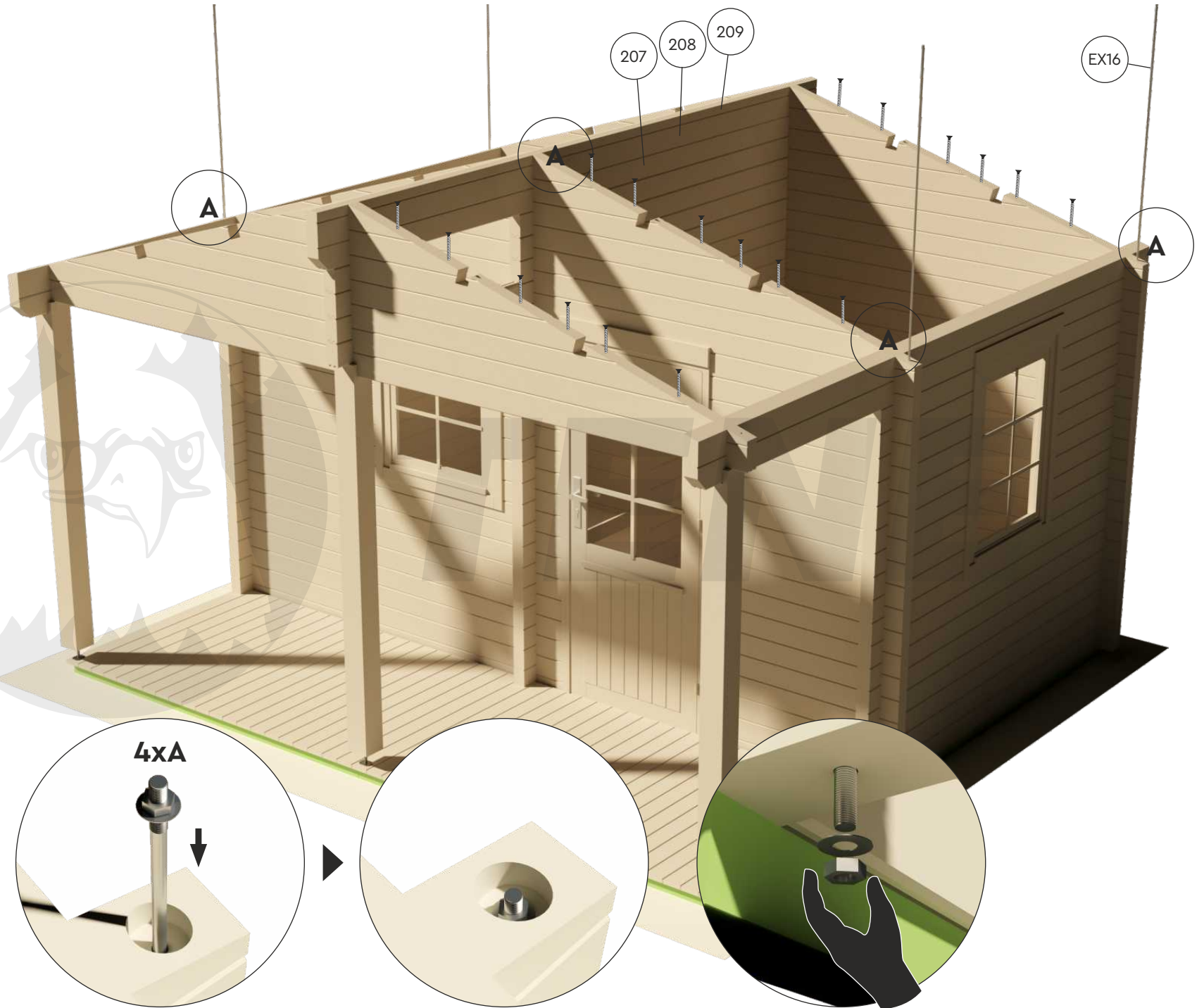

KALEVI 70

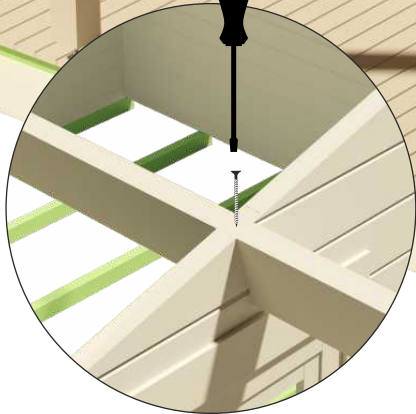
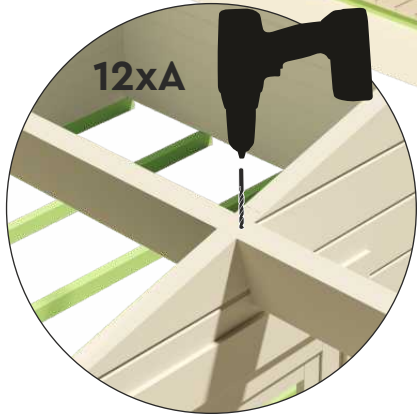
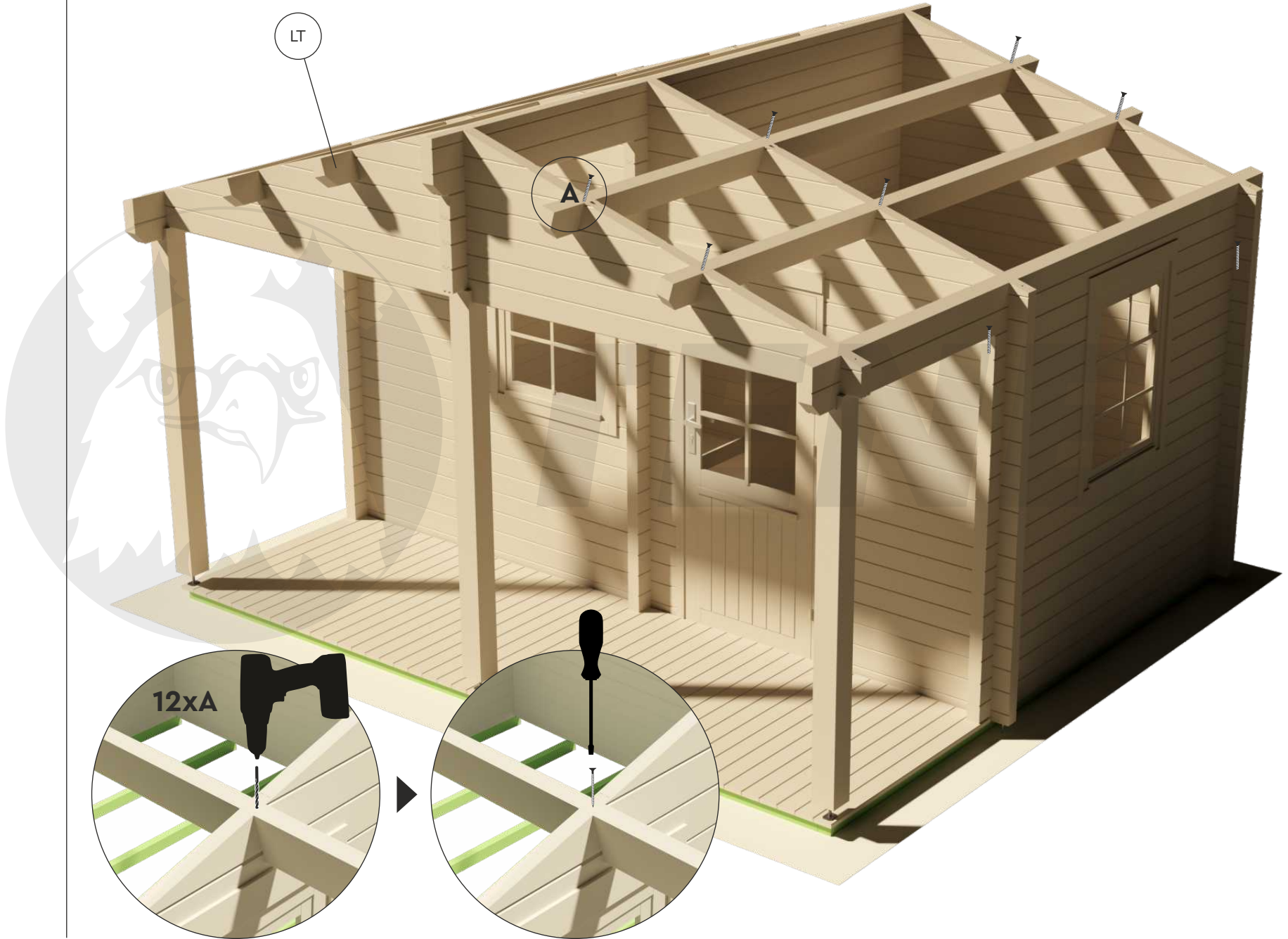

KALEVI 70

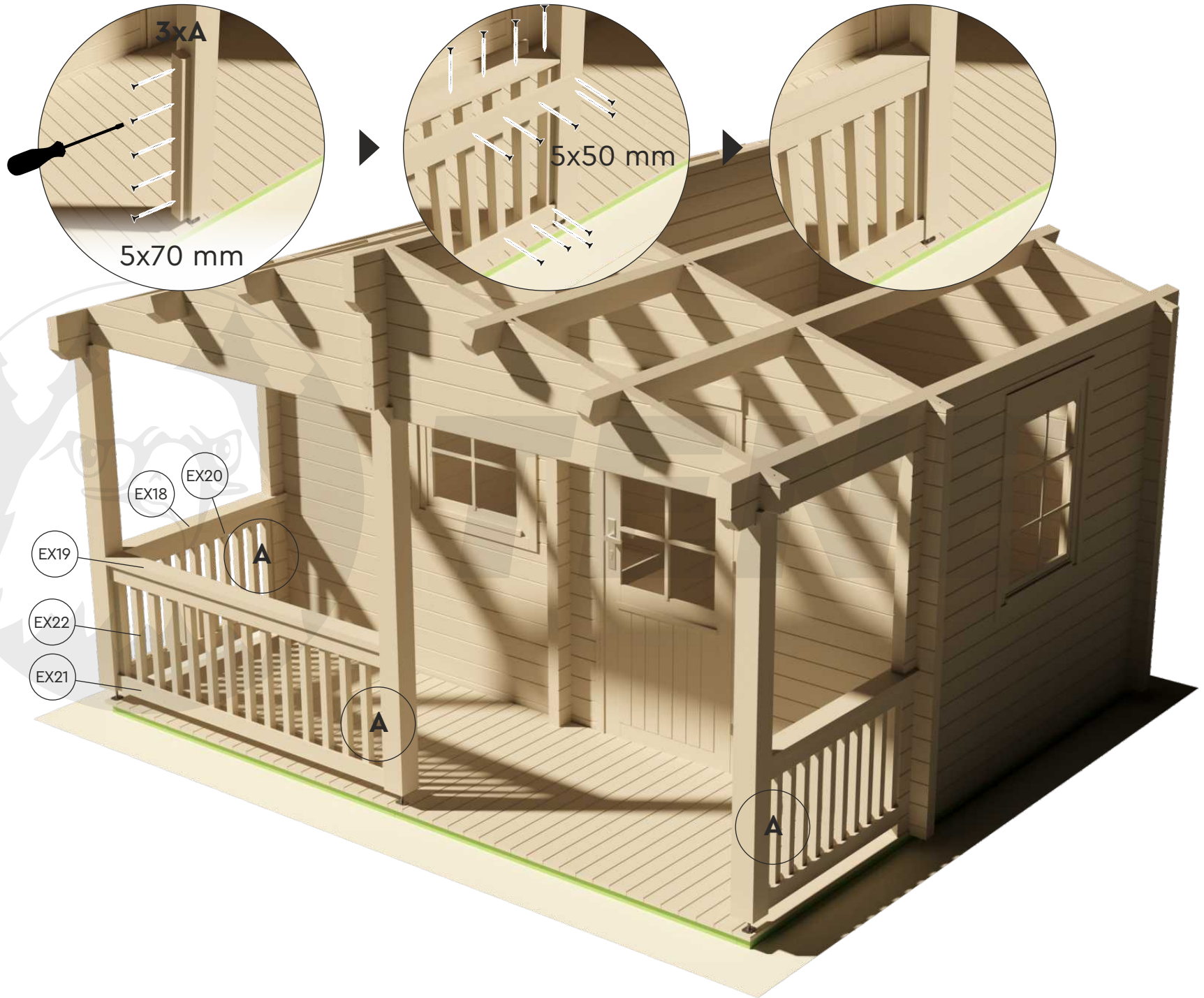

KALEVI 70

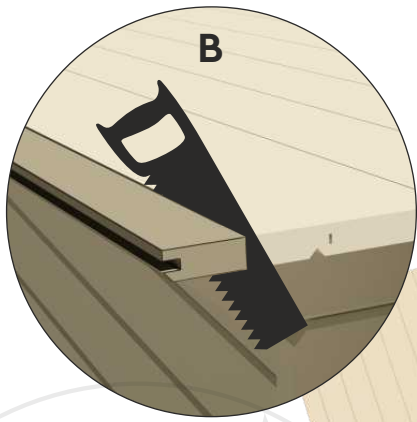

EX08

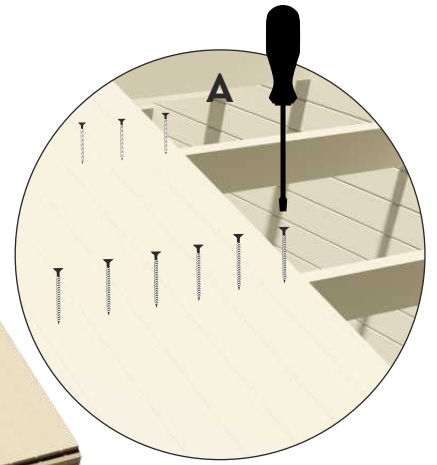

B

A1



KALEVI 70

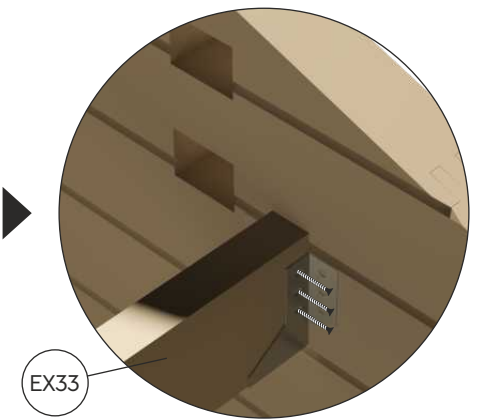
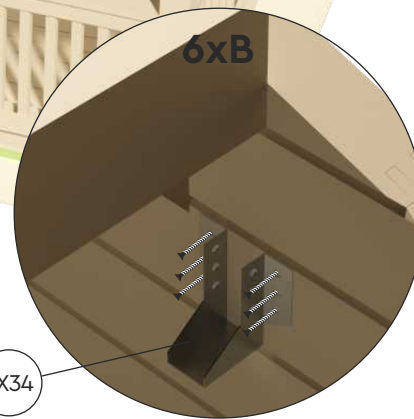
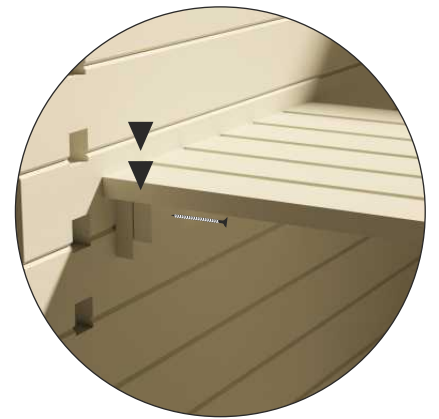
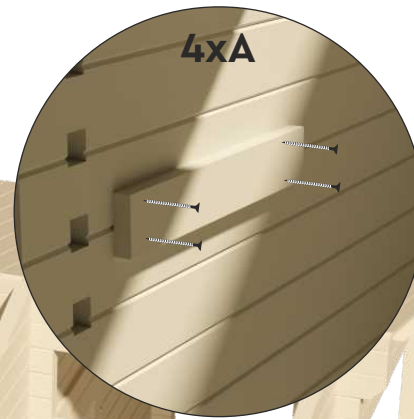
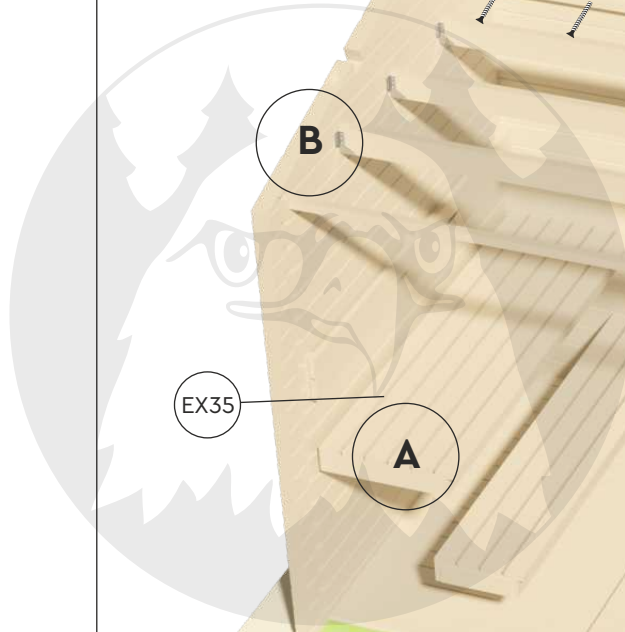

KALEVI 70

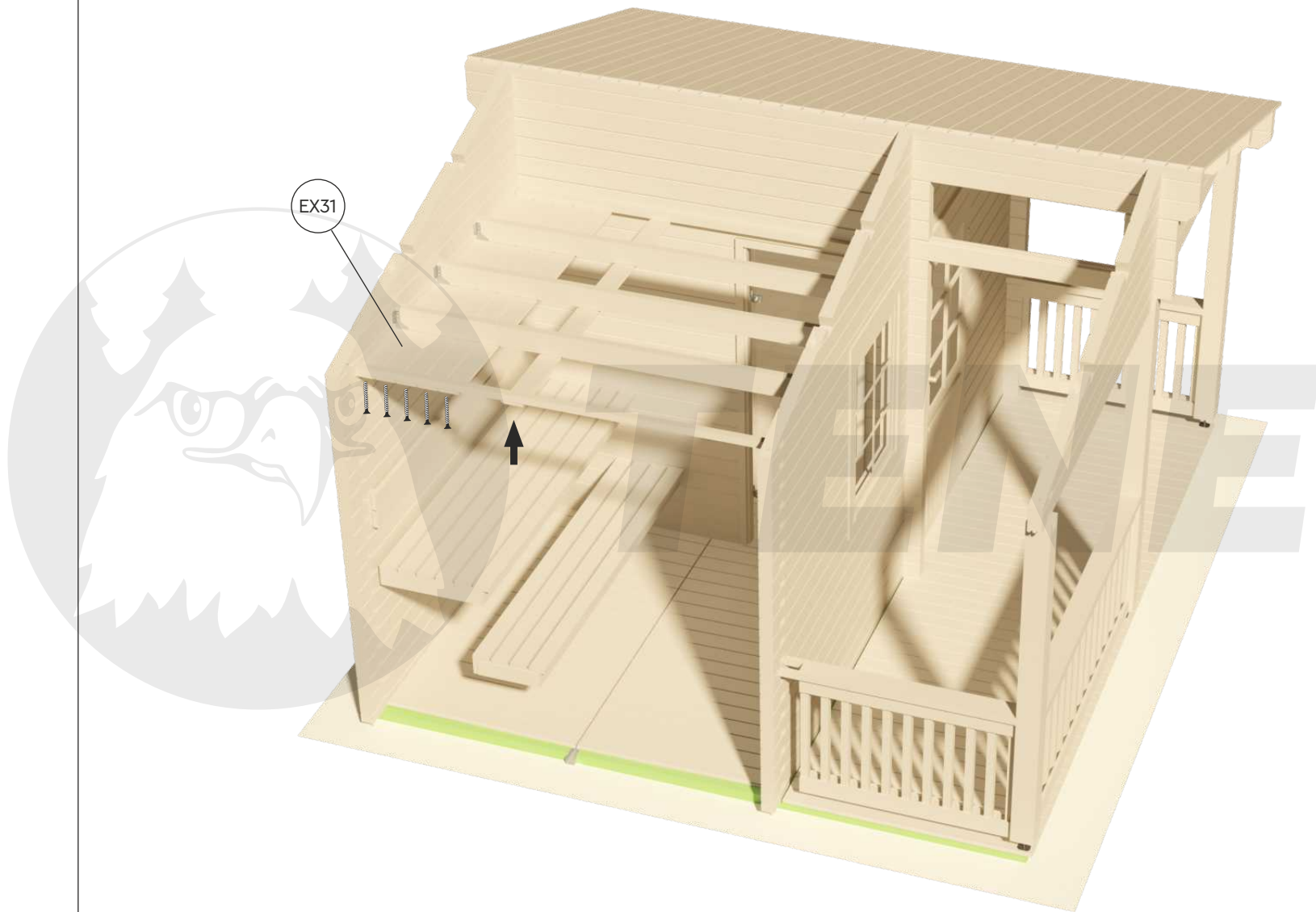

4x50 mm



KALEVI 70

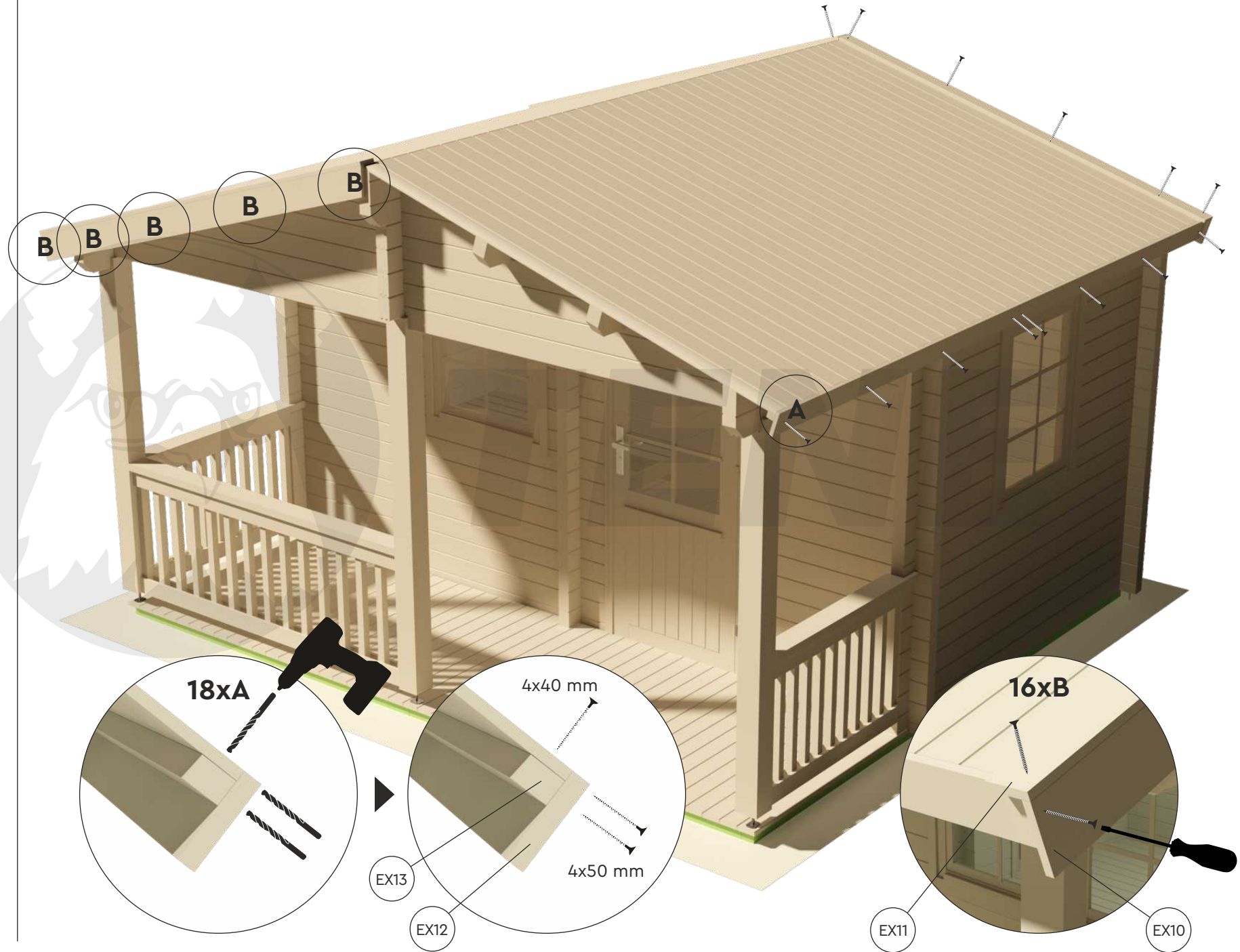

Ø 3 mm

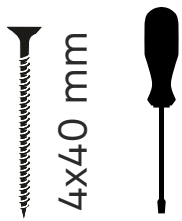

4x40 mm

KALEVI 70

