

# HANNU 40

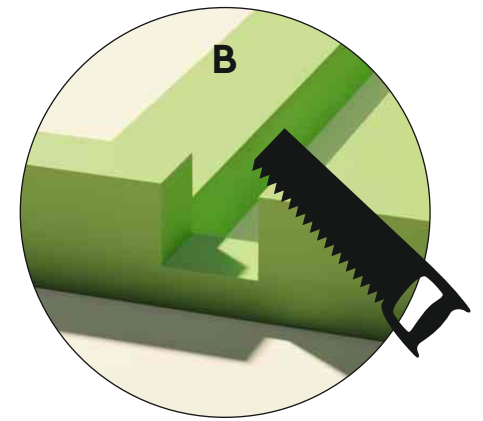

Ø 5 mm

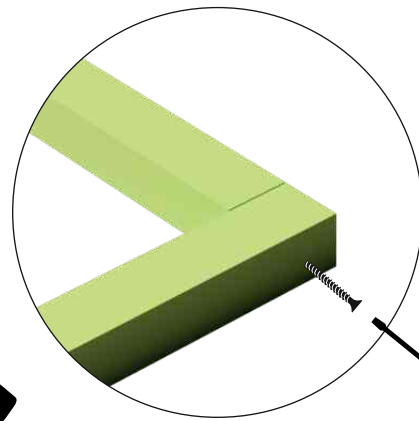
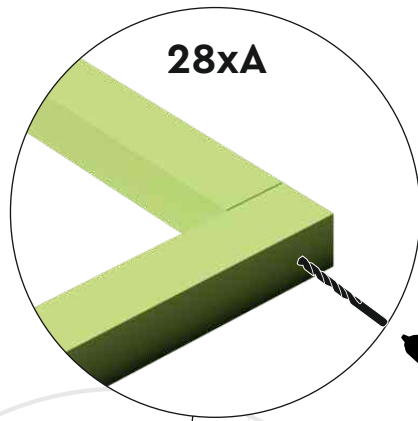

6x140 mm

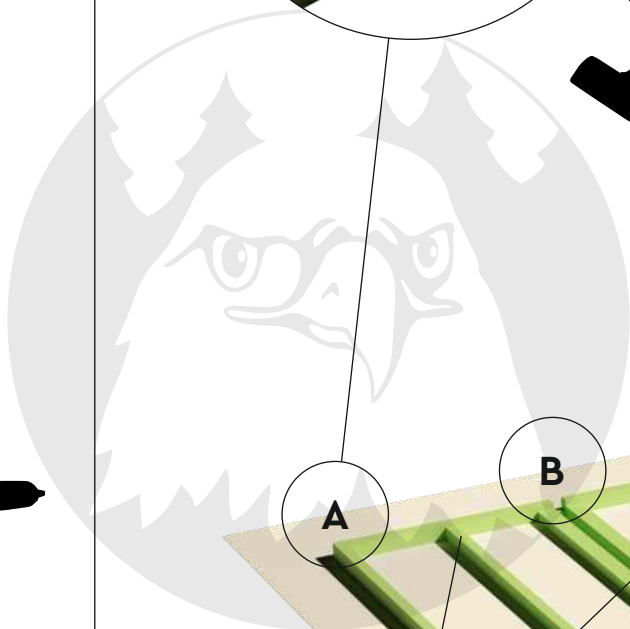

# TEPNE



FU01

FU04

FU03

FU02

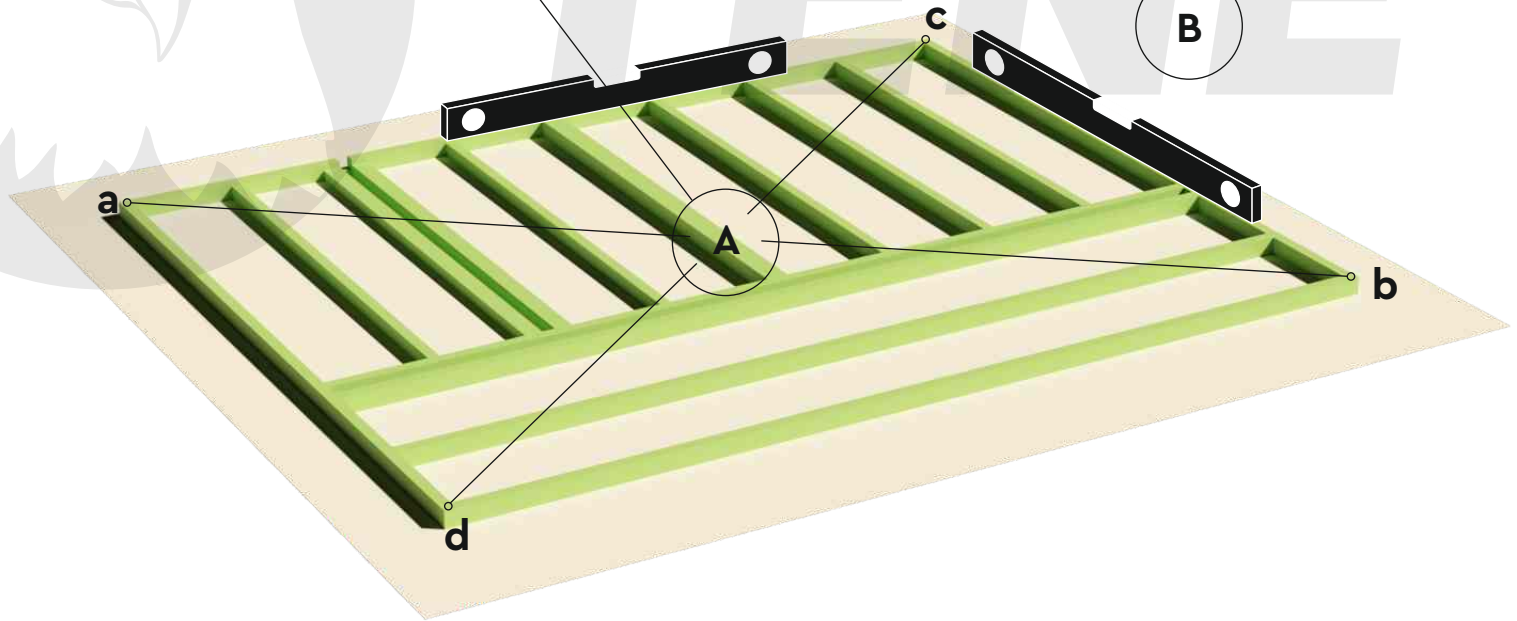
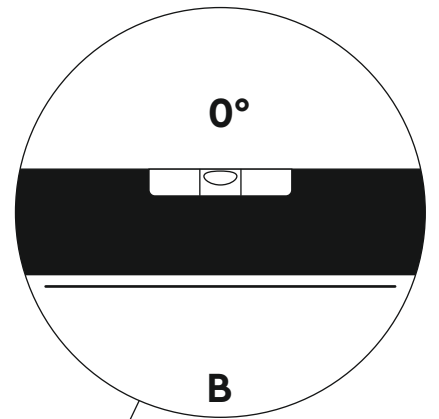
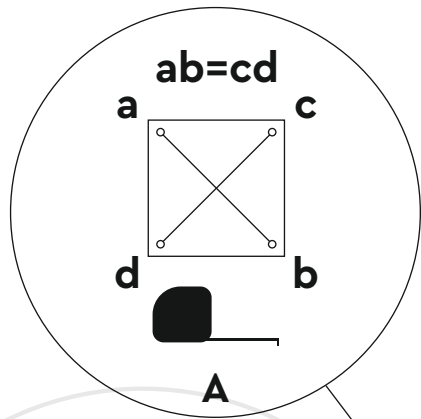

# HANNU 40



Ø 3 mm

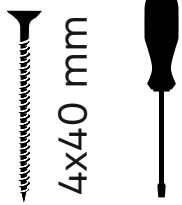

4x40 mm

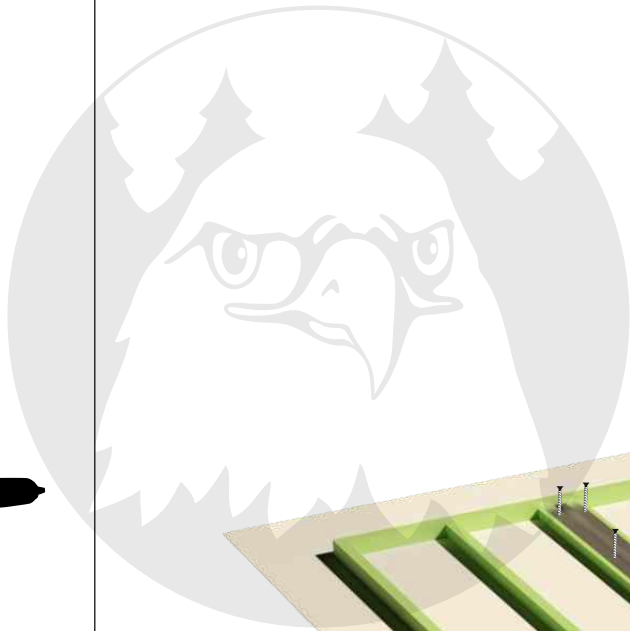

GU

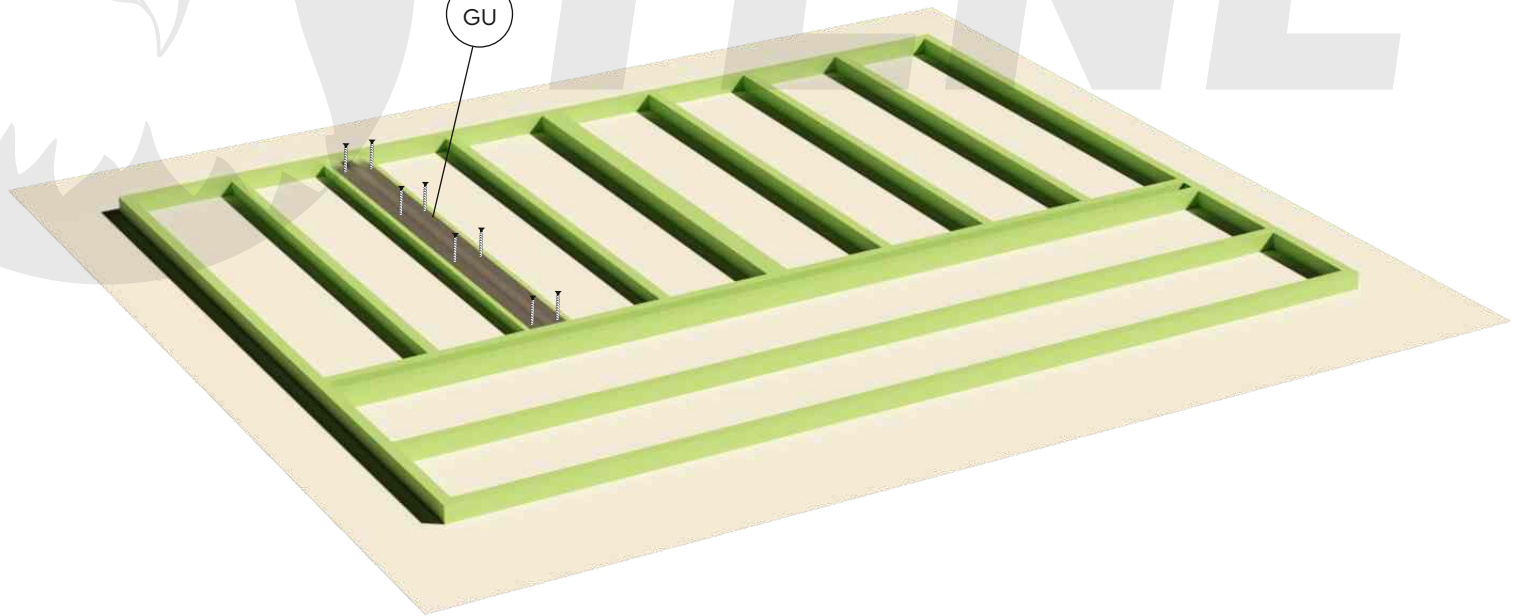

# HANNU 40

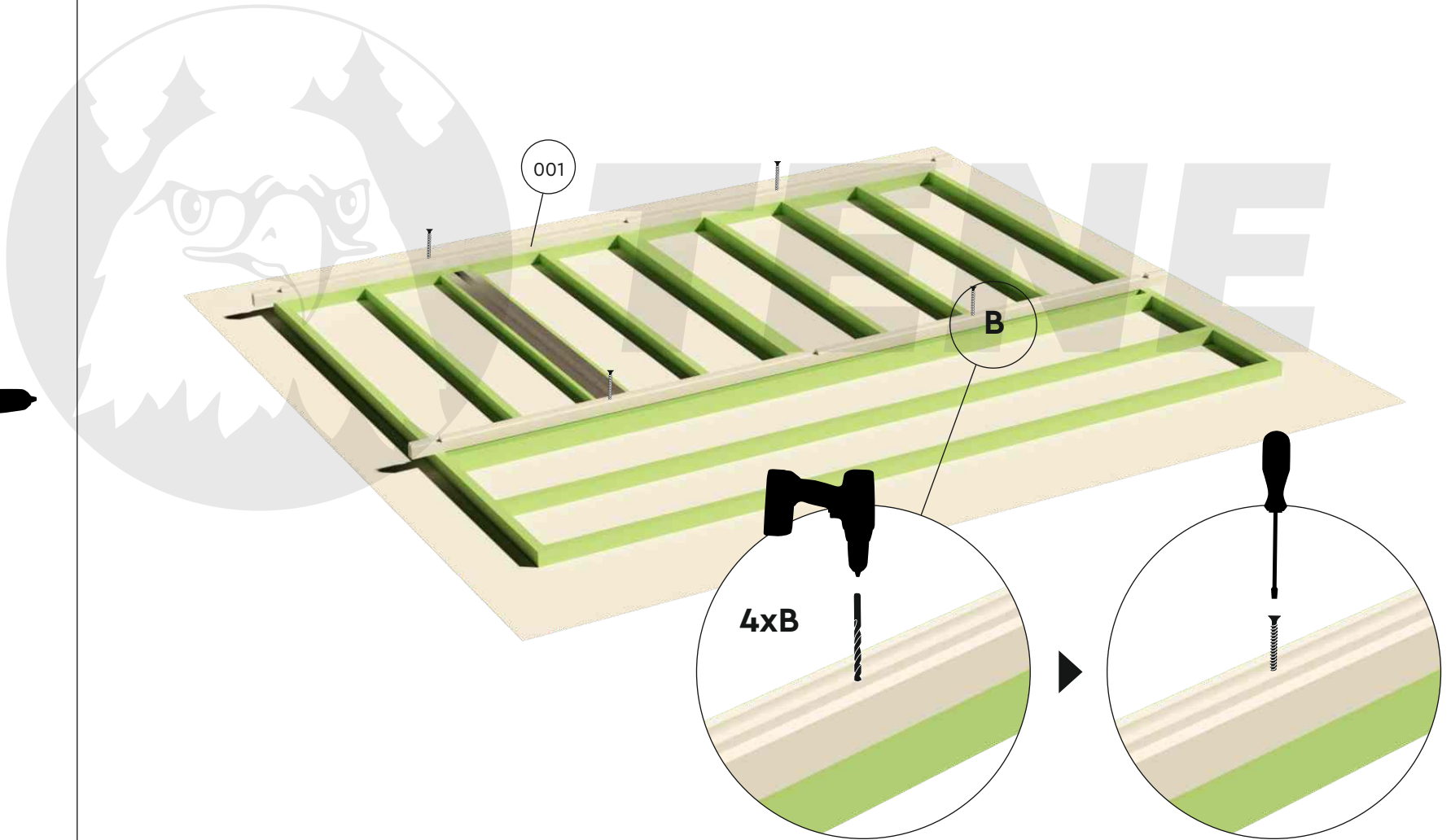
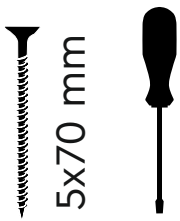

# HANNU 40

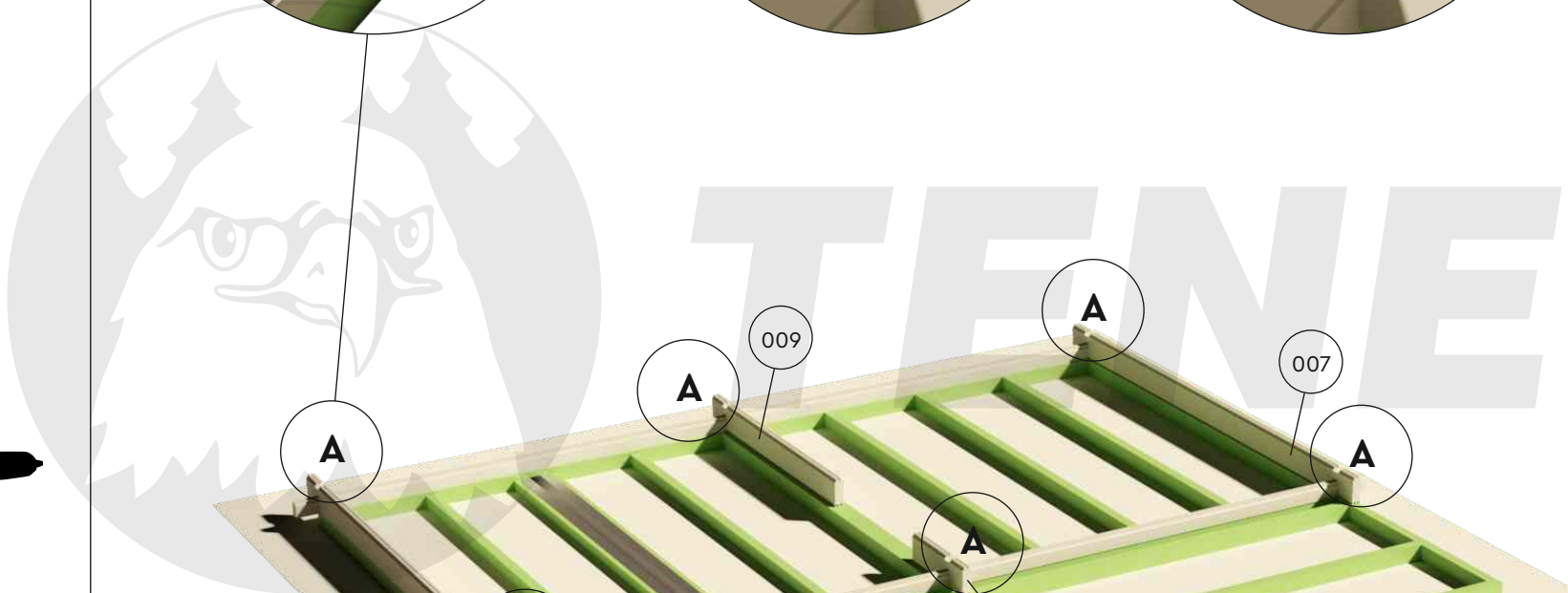
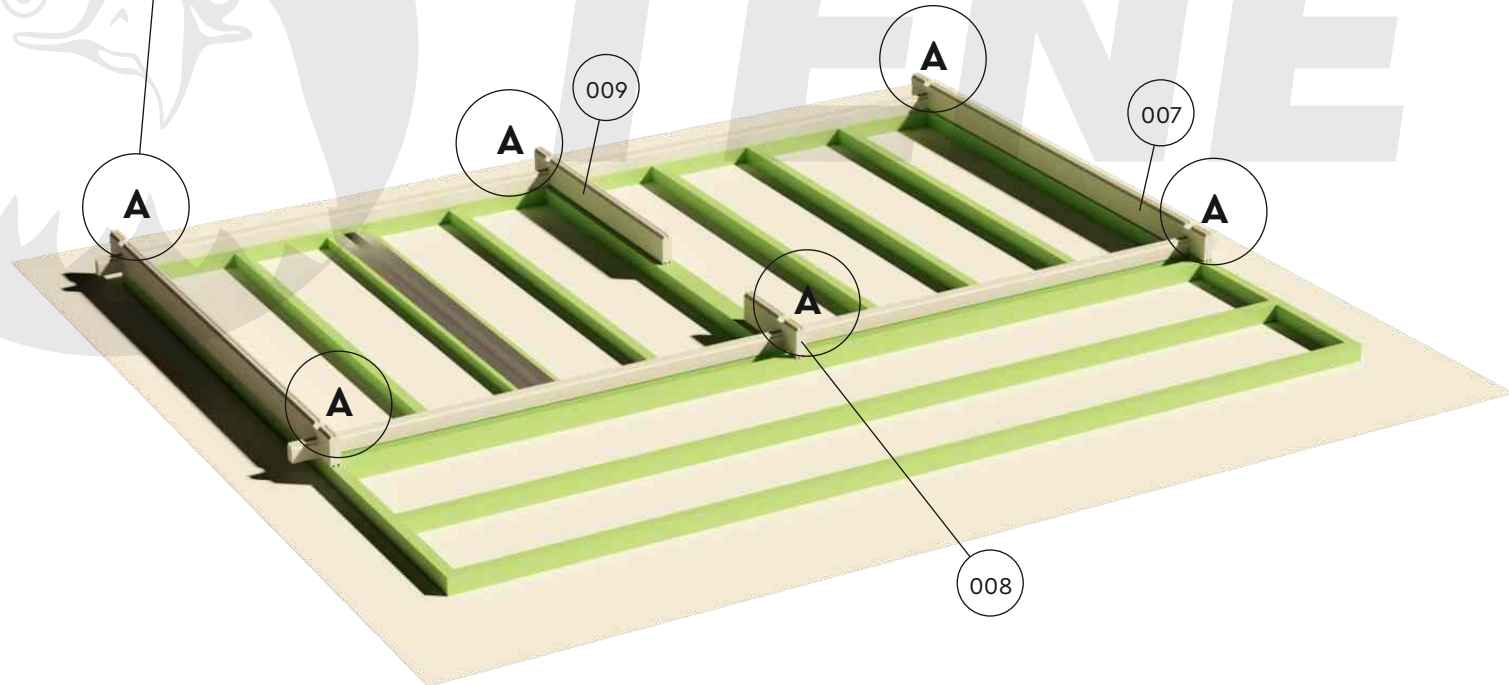
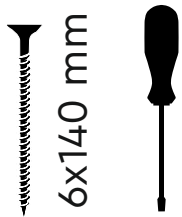
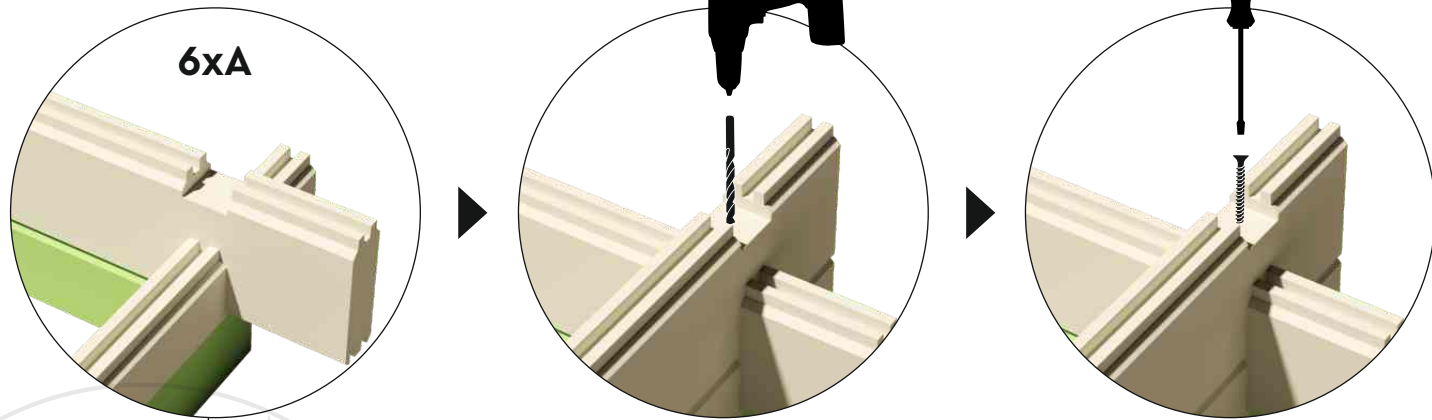

# HANNU 40

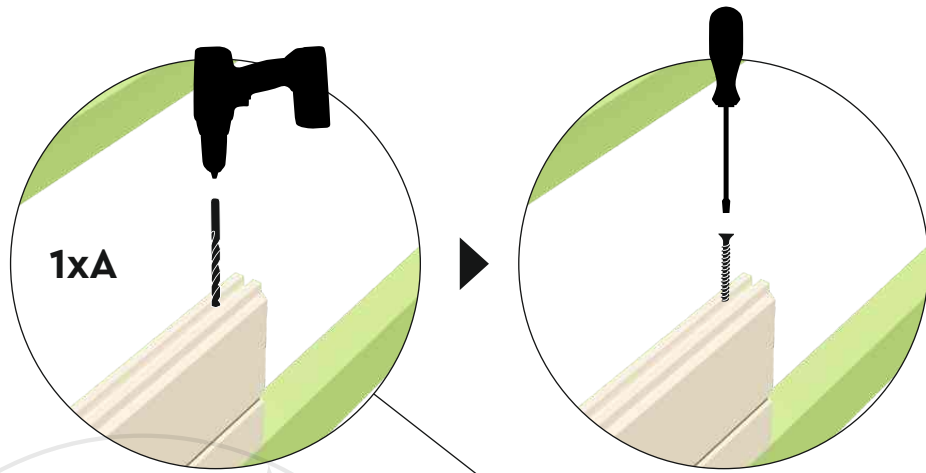

Ø 5 mm

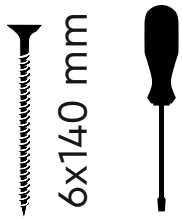

6x140 mm

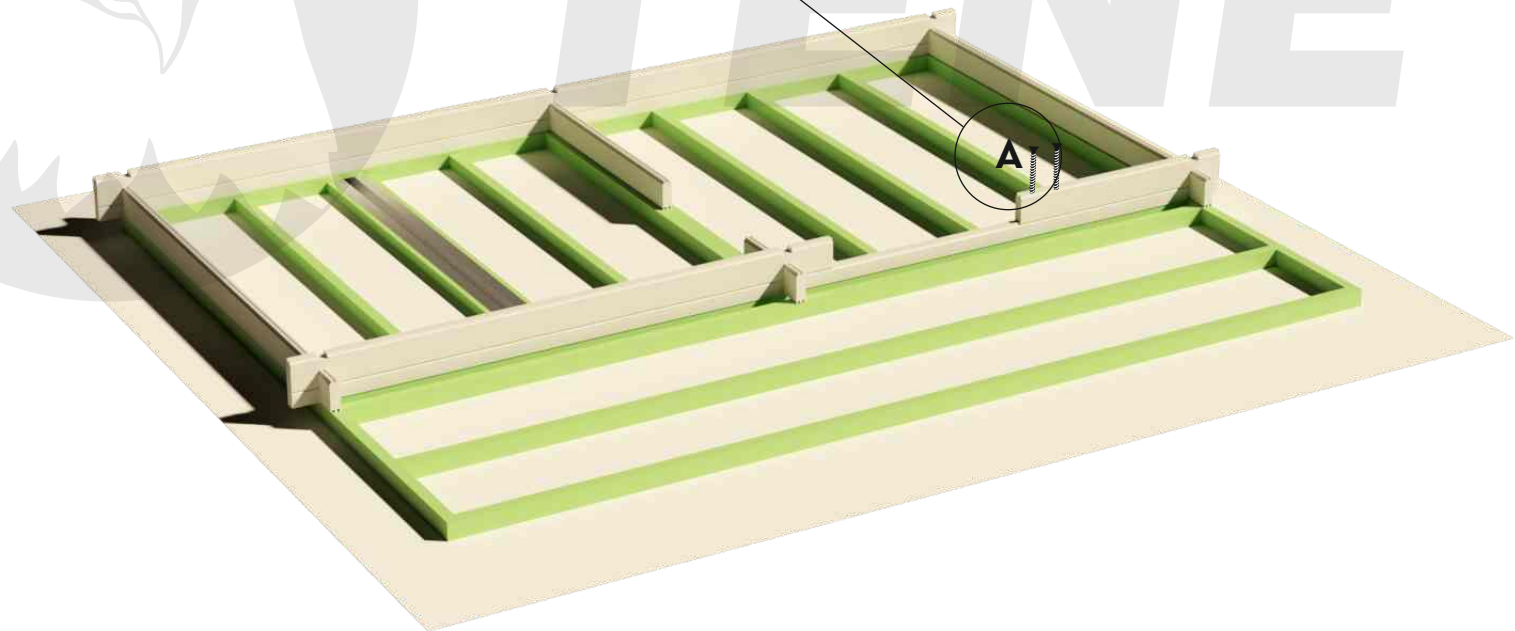

# HANNU 40

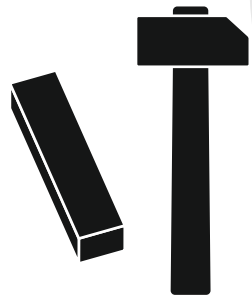
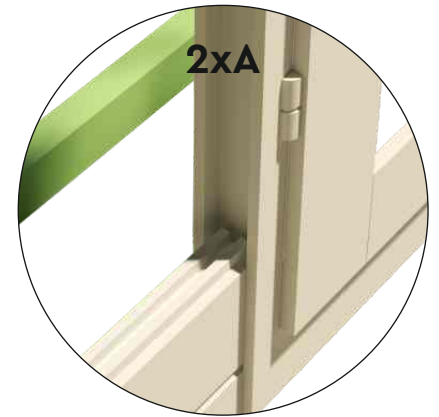
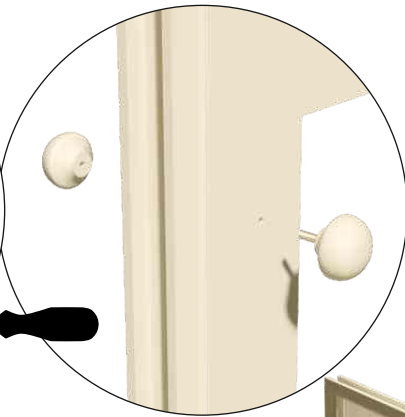
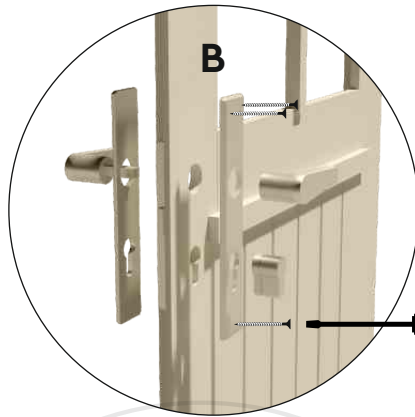
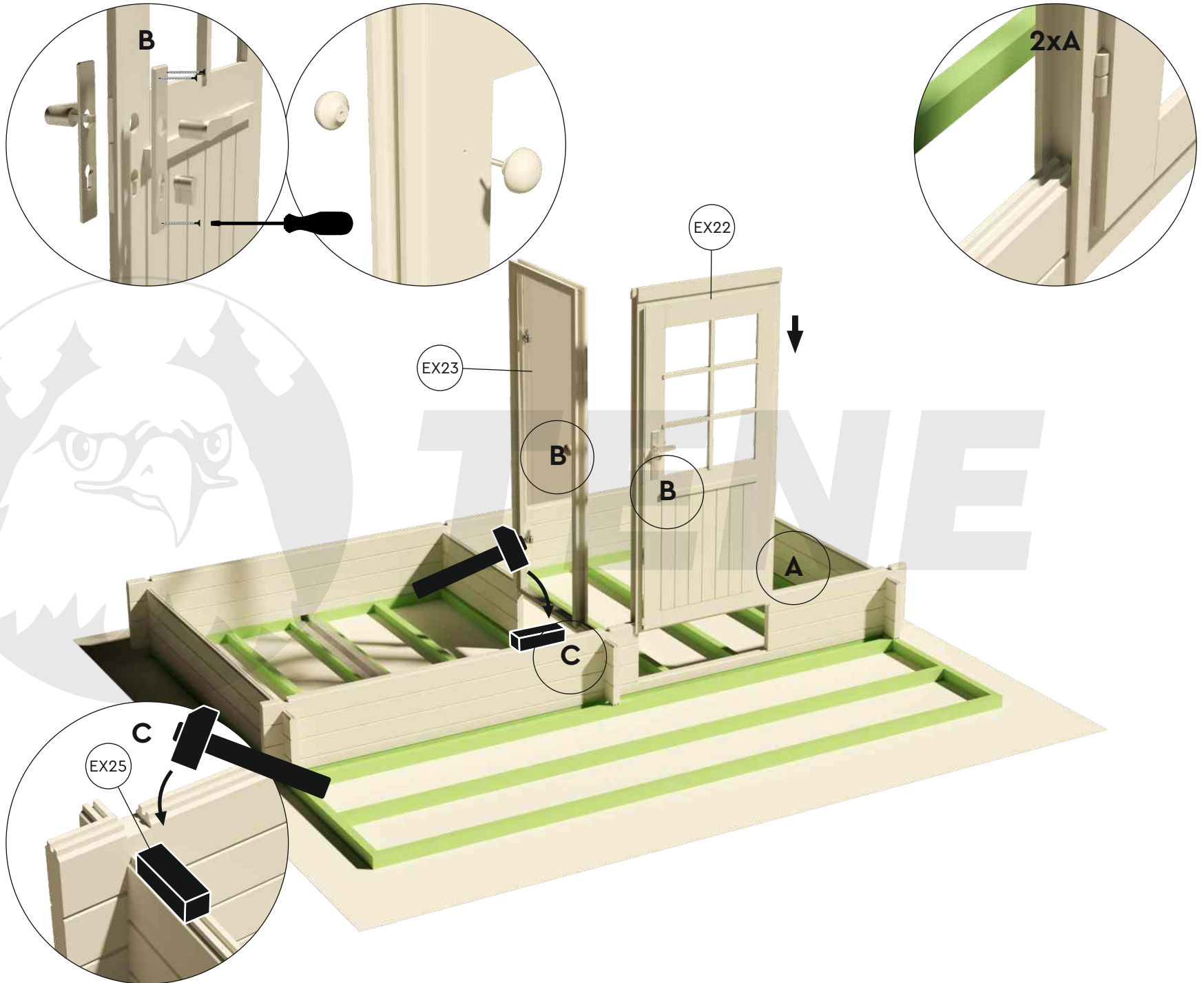





# HANNU 40

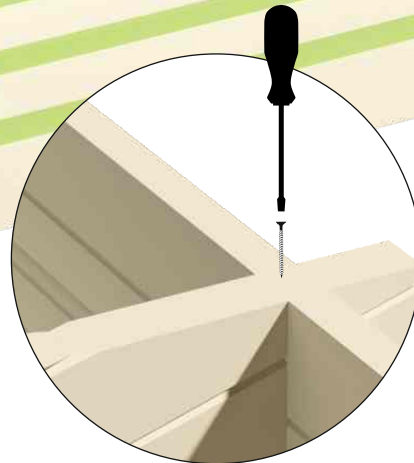
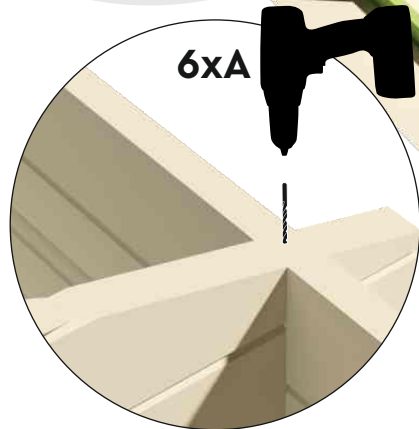
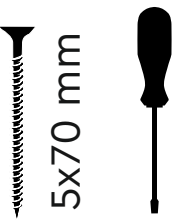
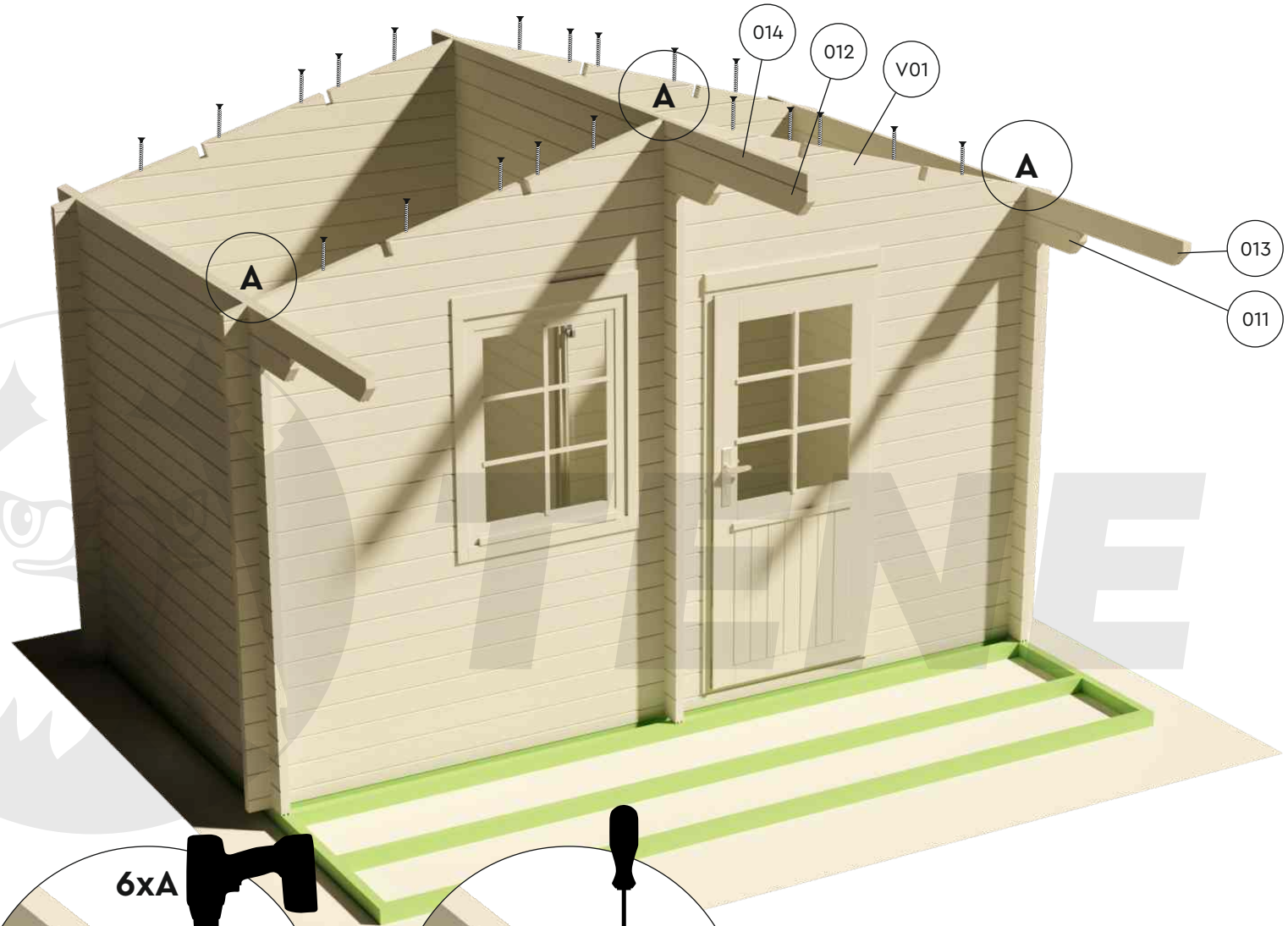

# HANNU 40

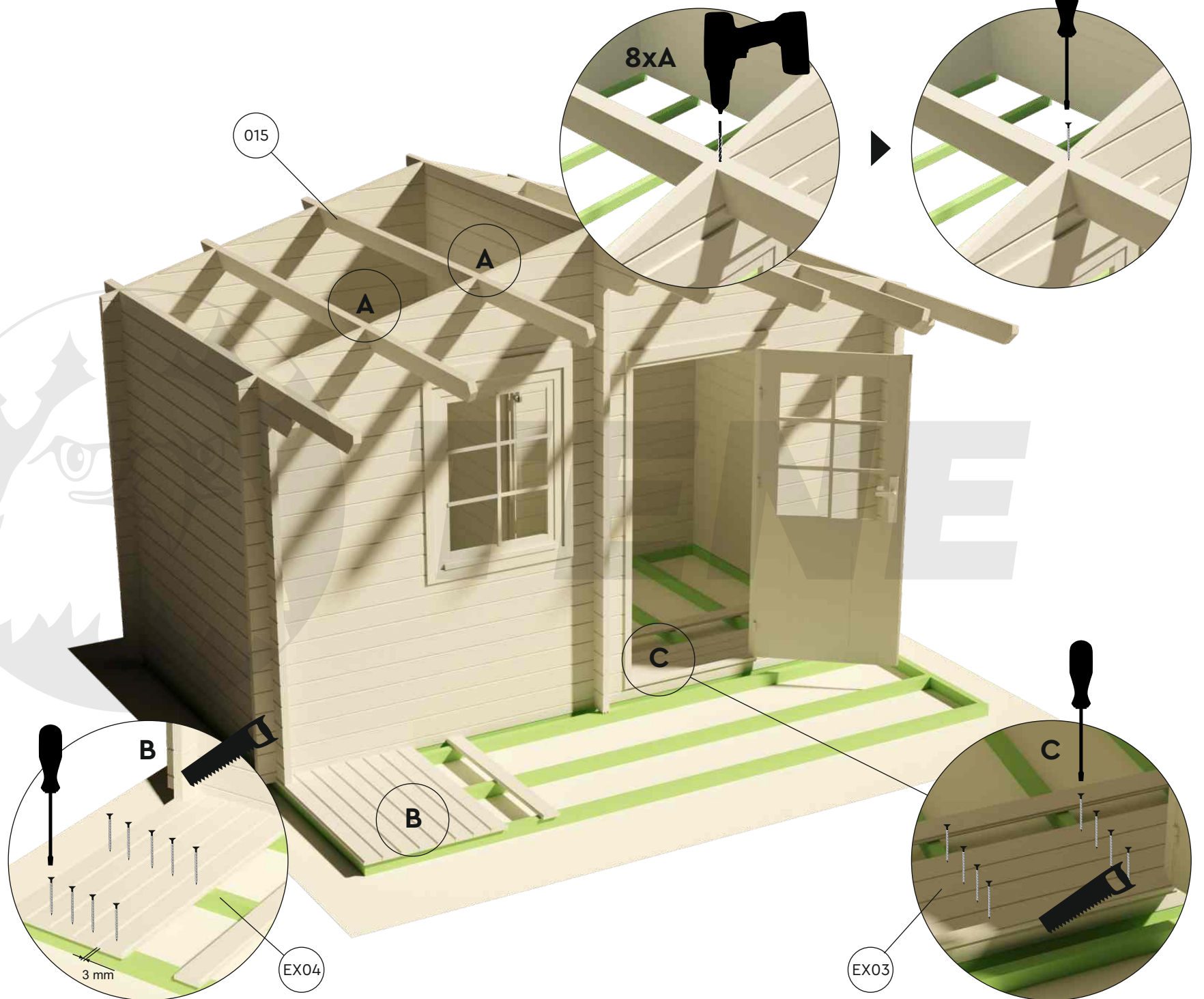
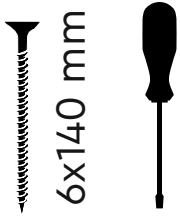

# HANNU 40

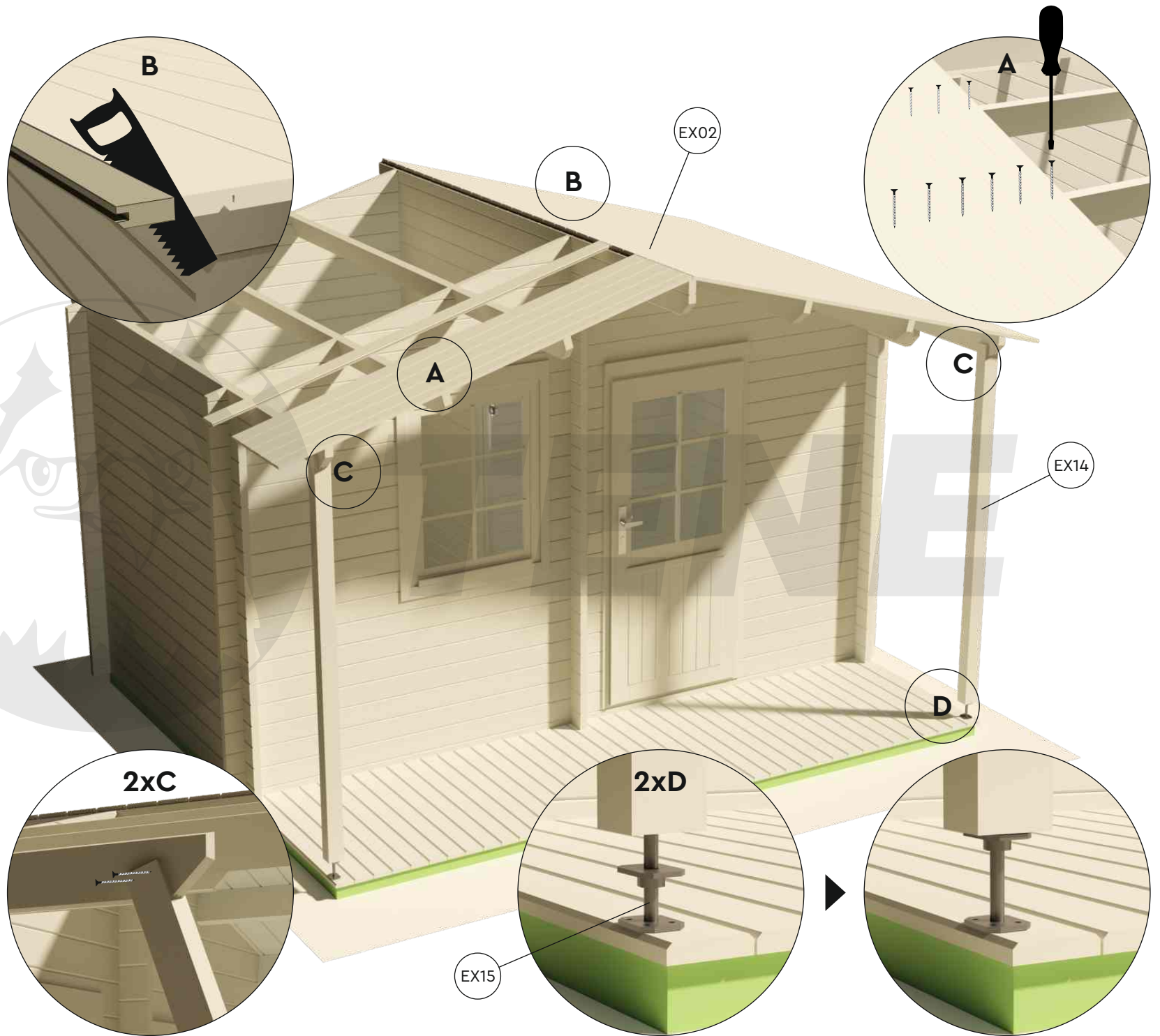

# HANNU 40

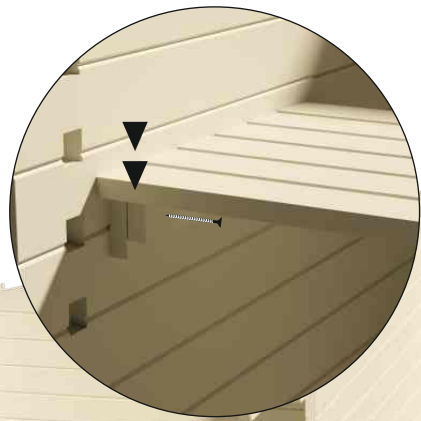
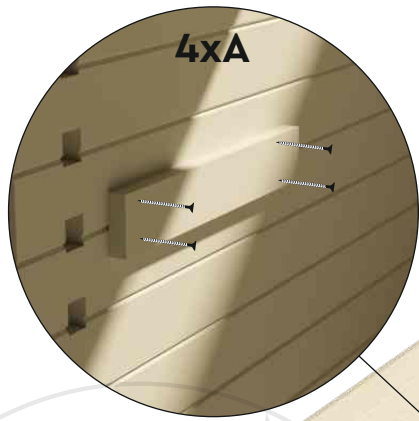

EX17

A

A

# HANNU 40

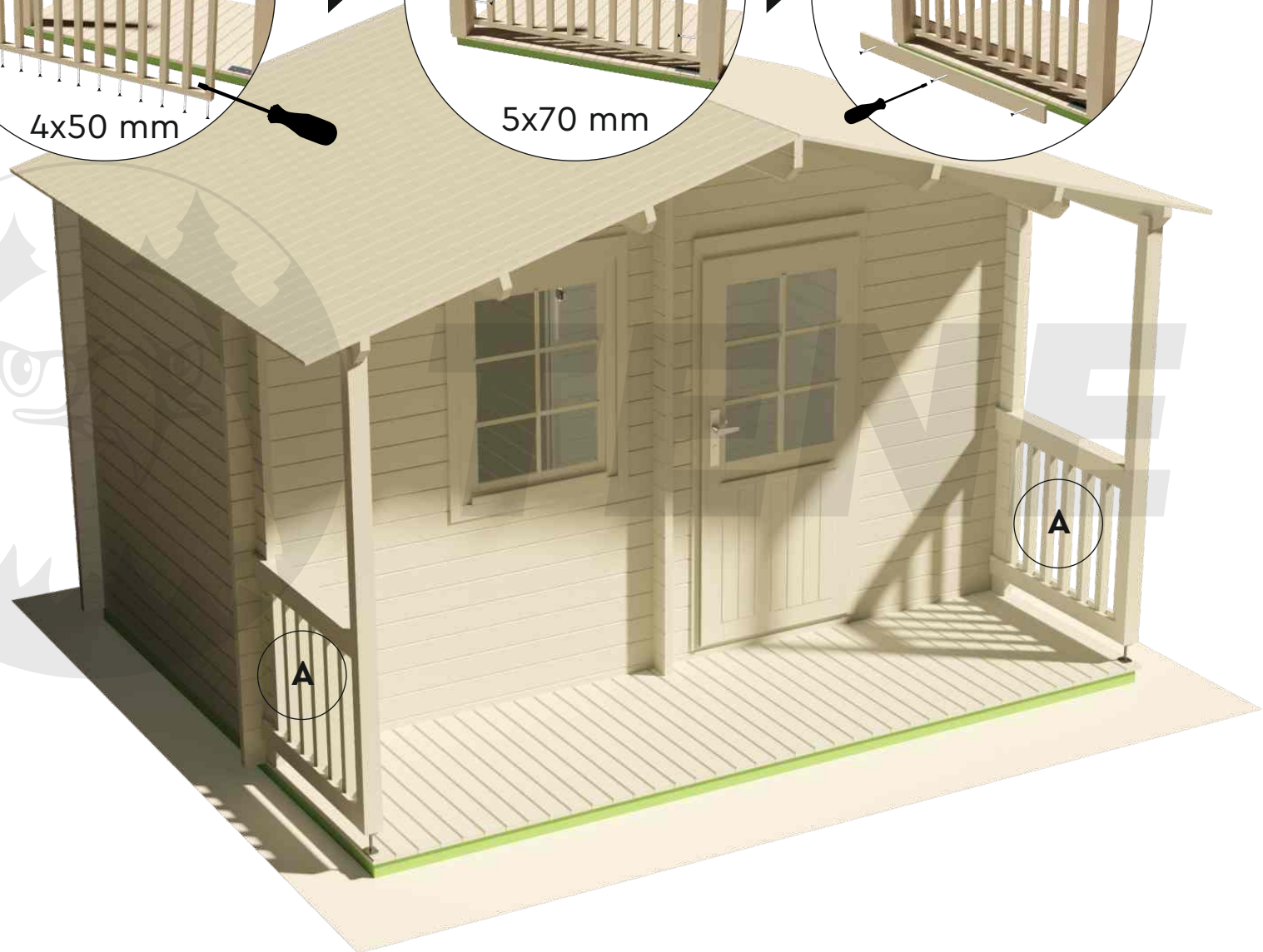
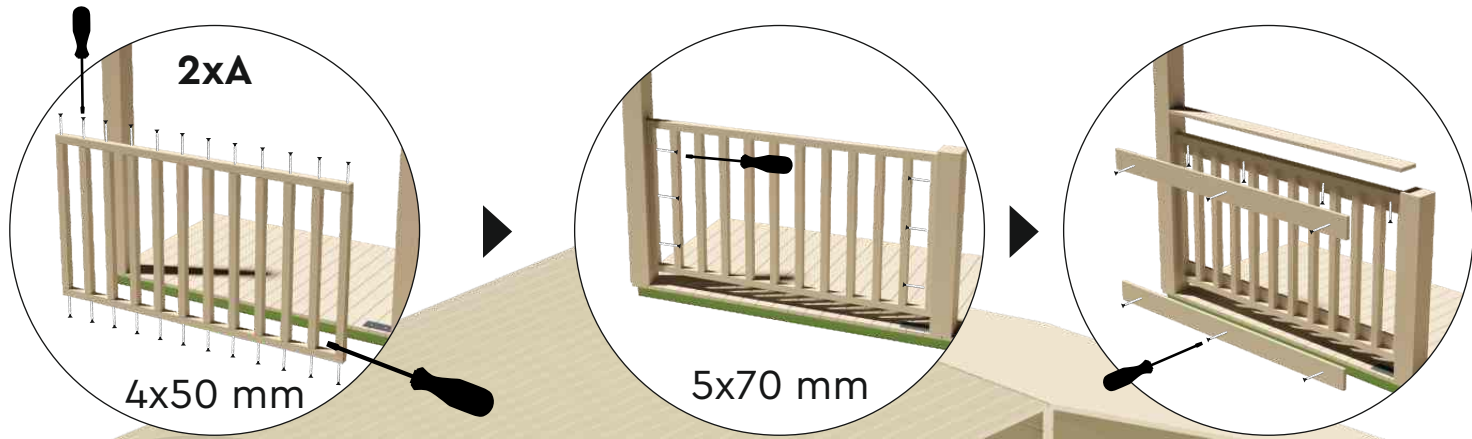

# HANNU 40

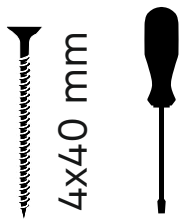
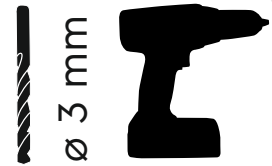
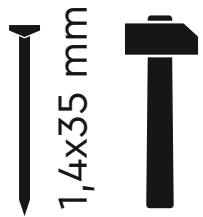
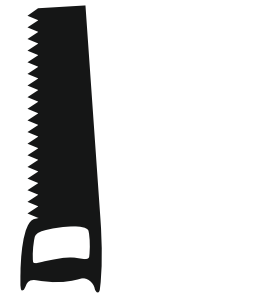

15/18

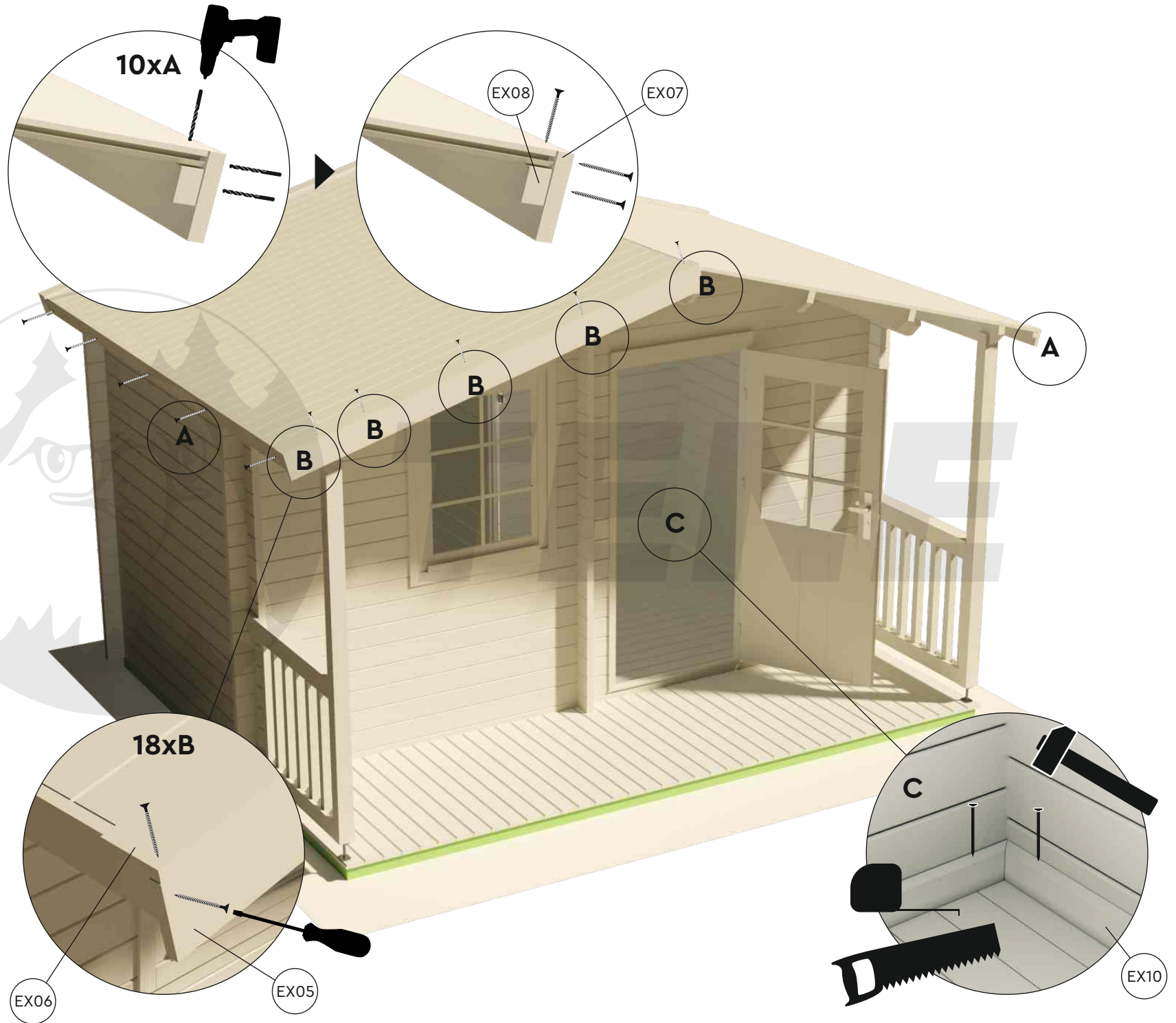

10xA

EX08

EX07

A

B

B

B

B

B

A

C

18xB

EX06

EX05

C

EX10

# HANNU 40

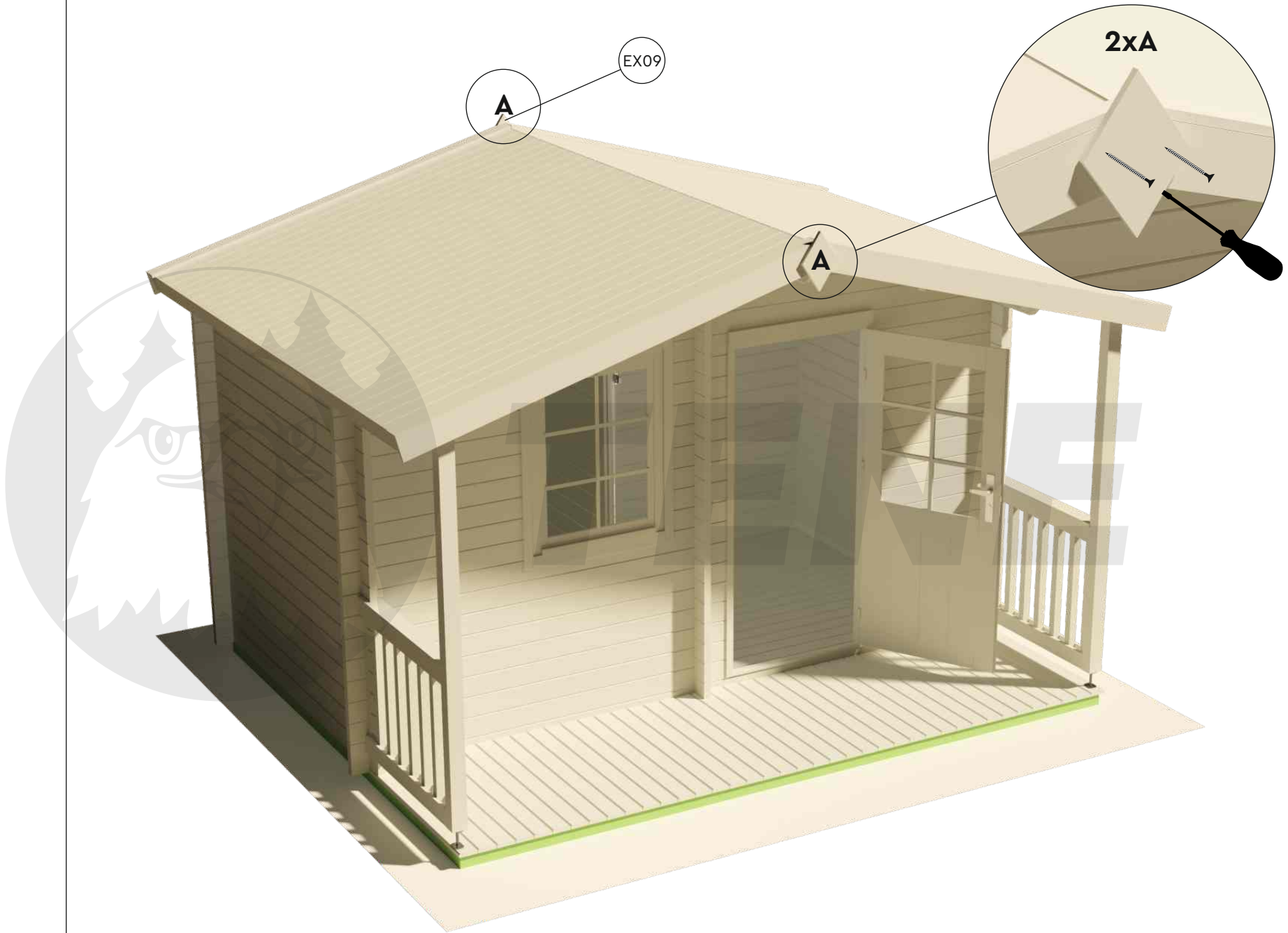

4x40 mm





# HANNU 40

