

# RAMSI 28

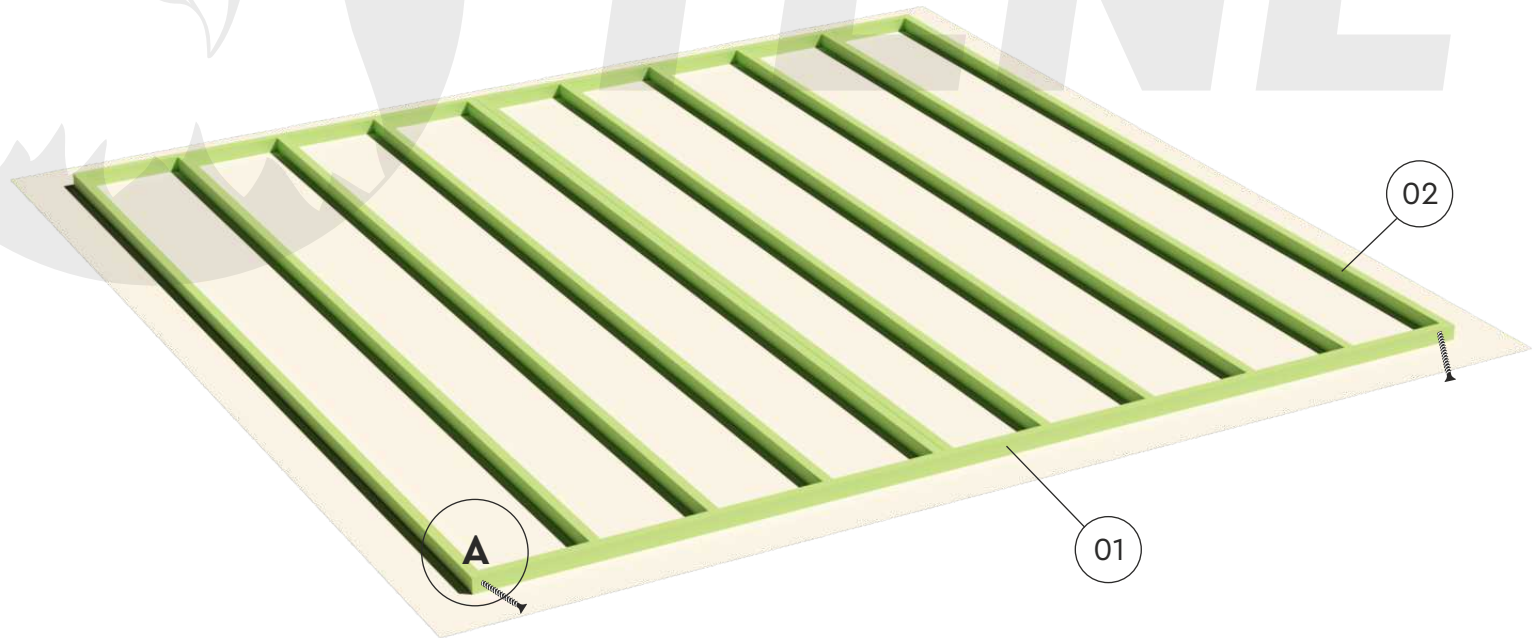

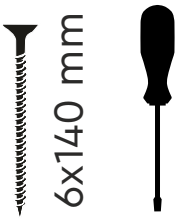

# RAMSI 28

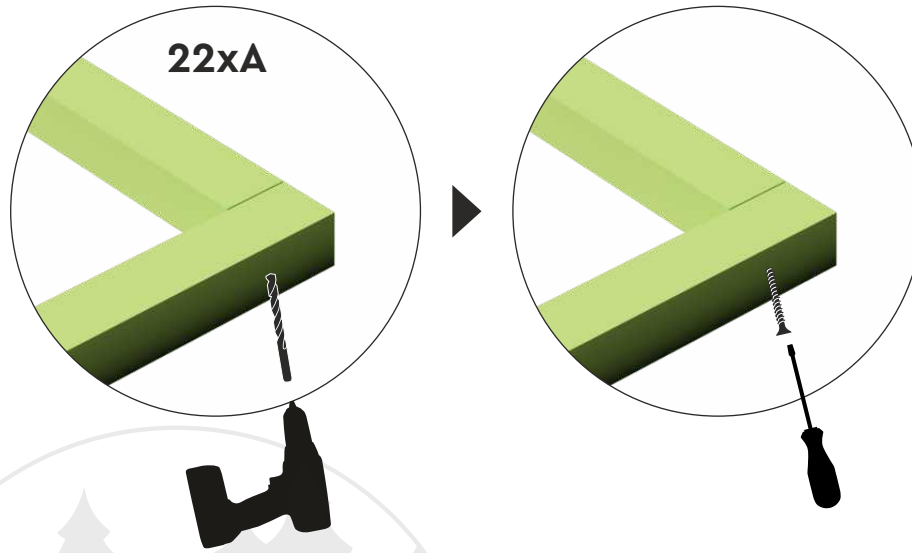
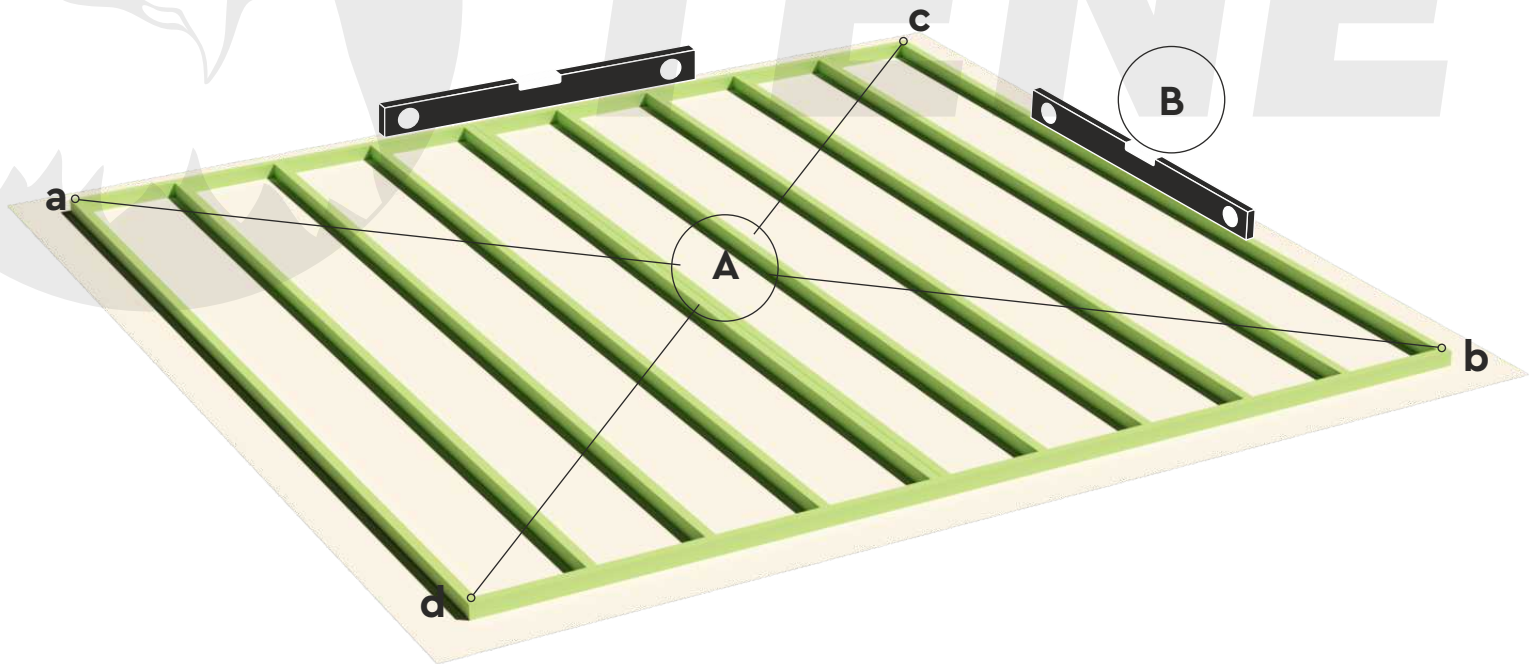
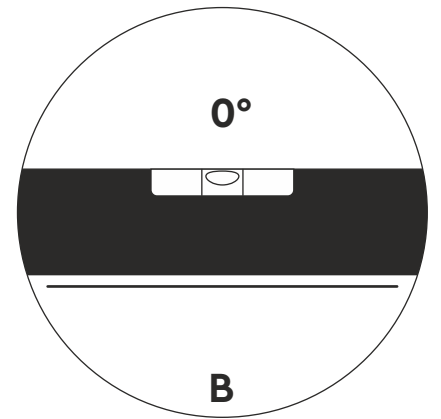
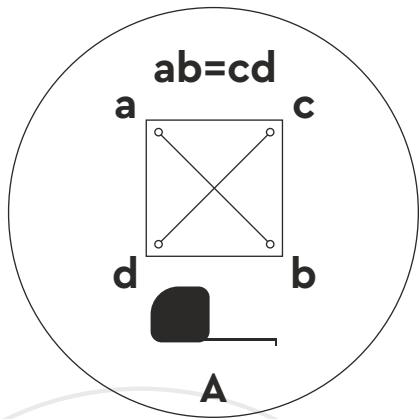
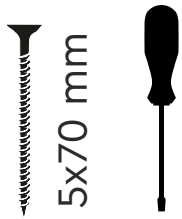
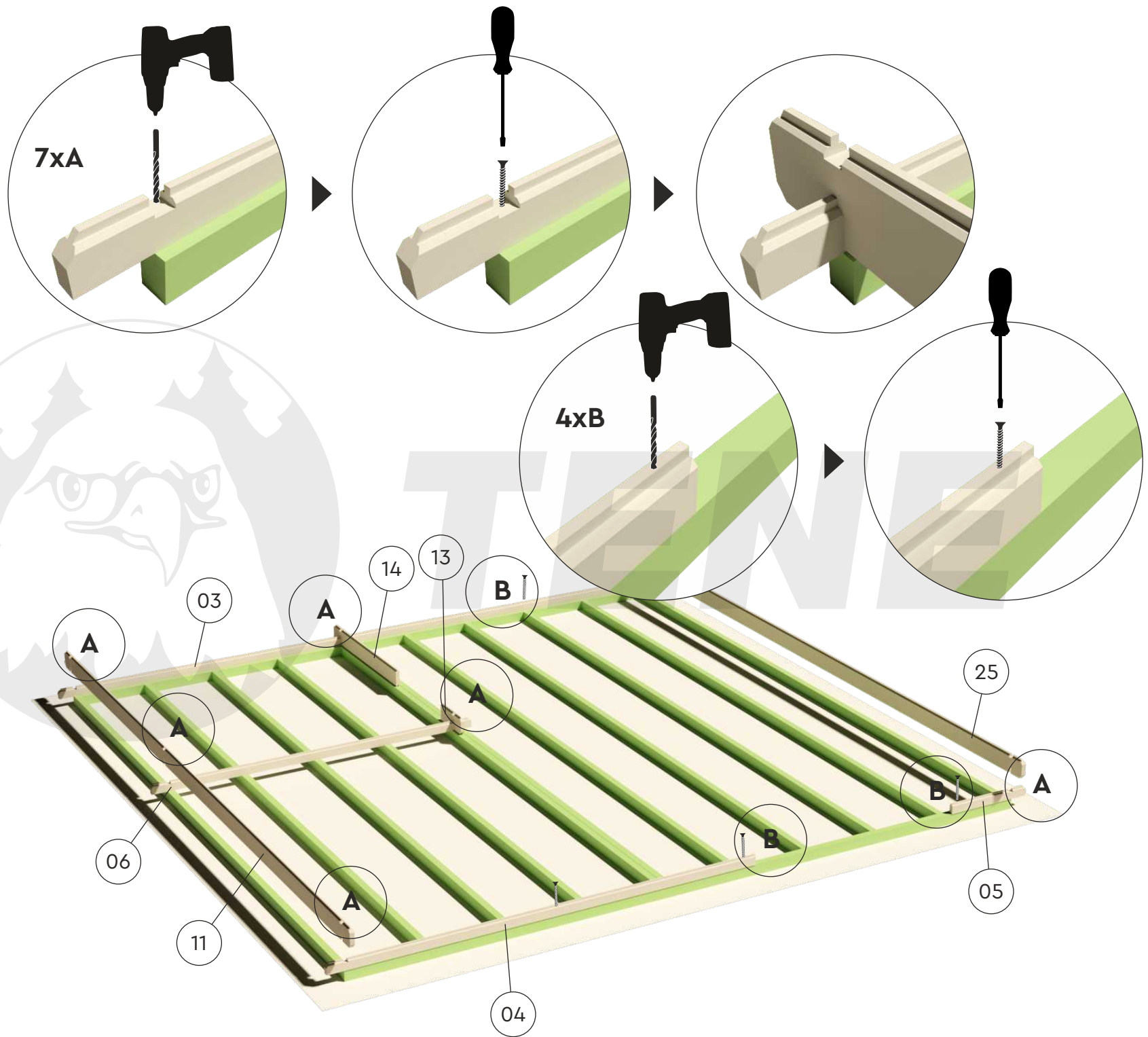

# RAMSI 28

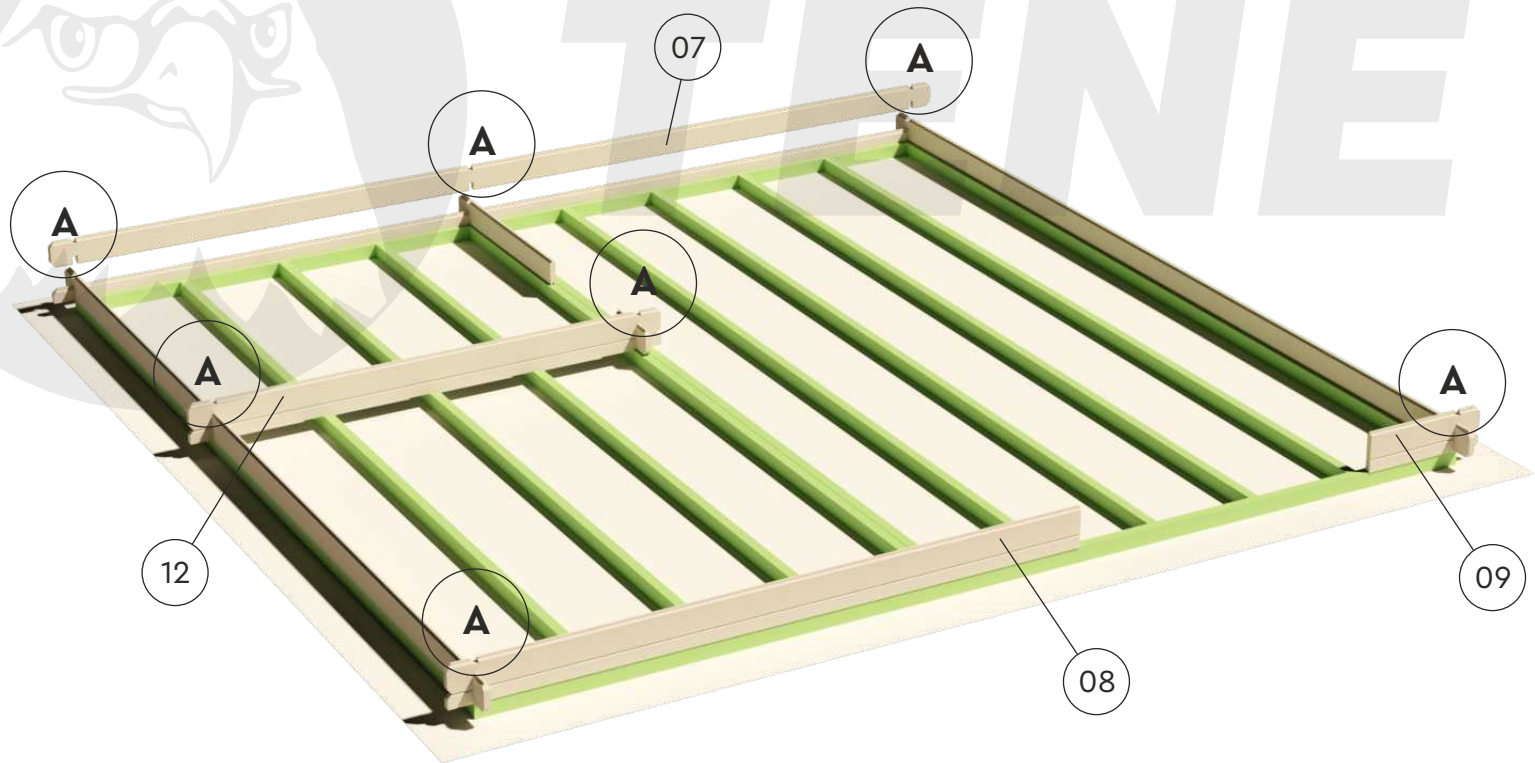
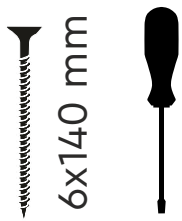
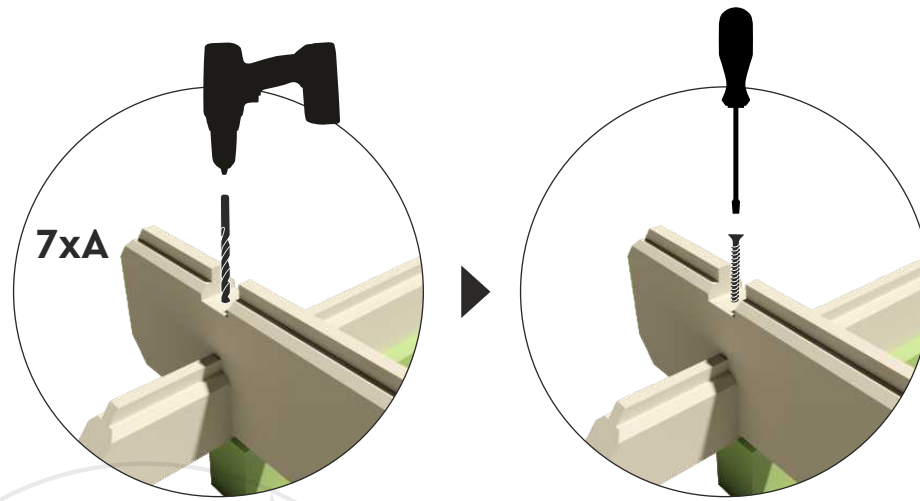

# RAMSI 28

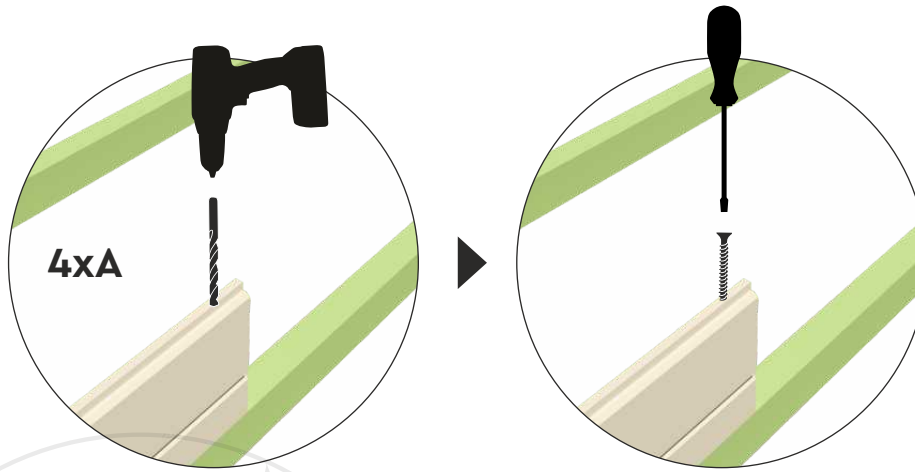

Ø 5 mm

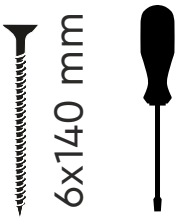

6x140 mm

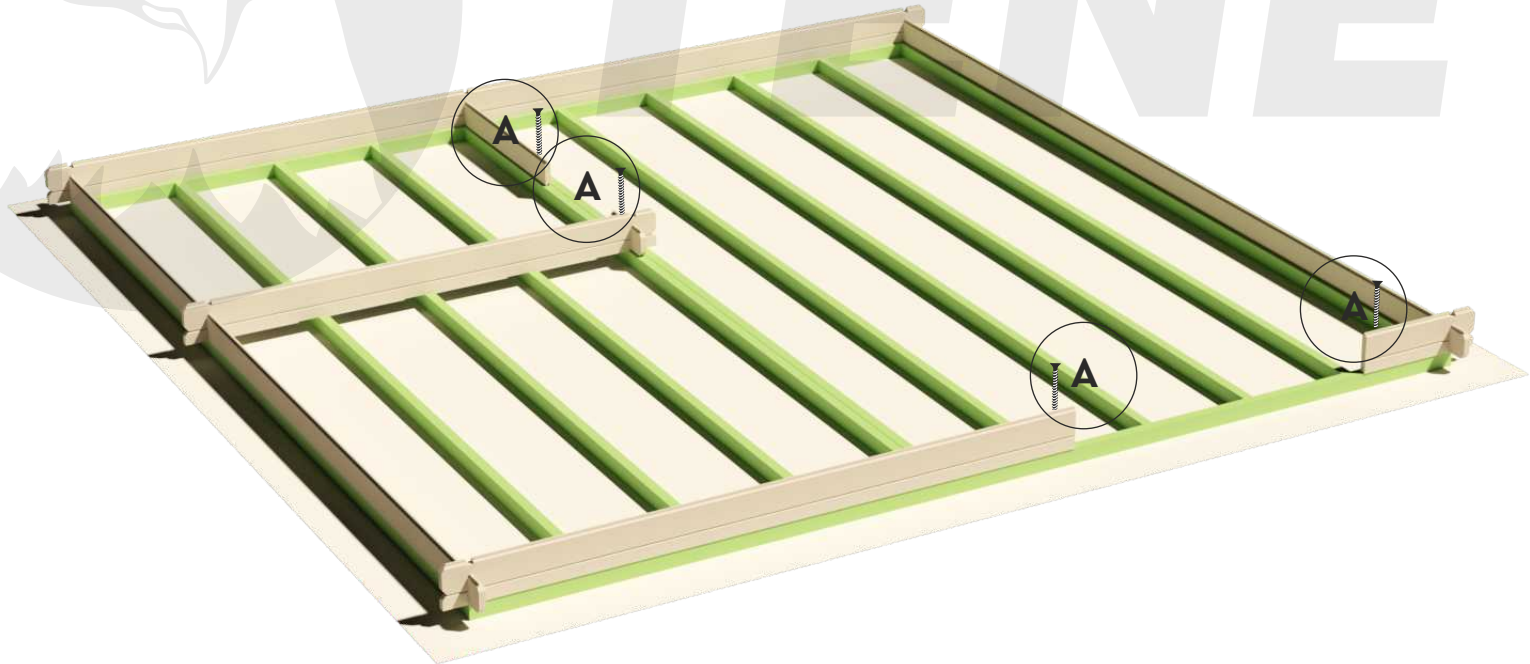

# RAMSI 28

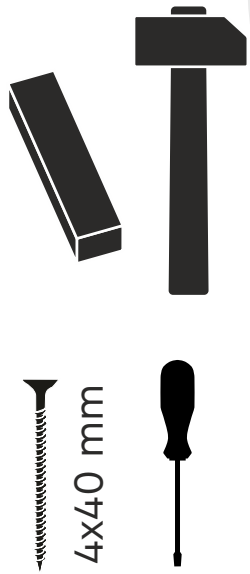
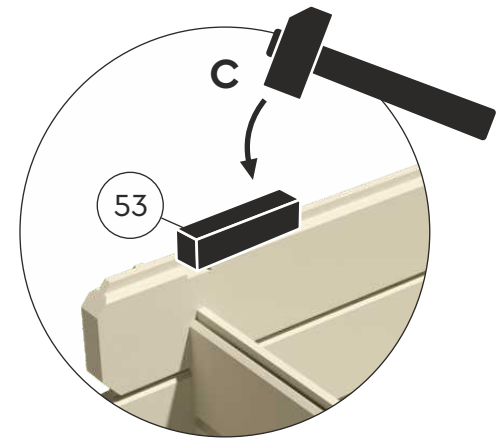
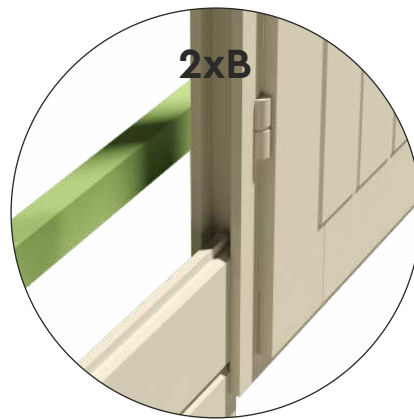
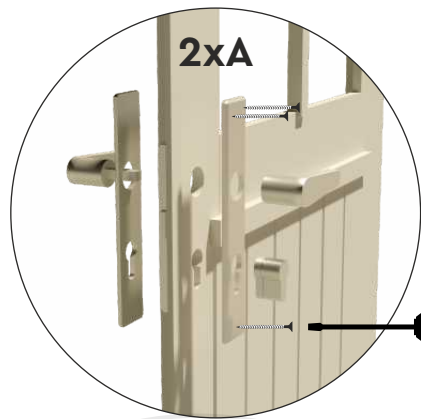
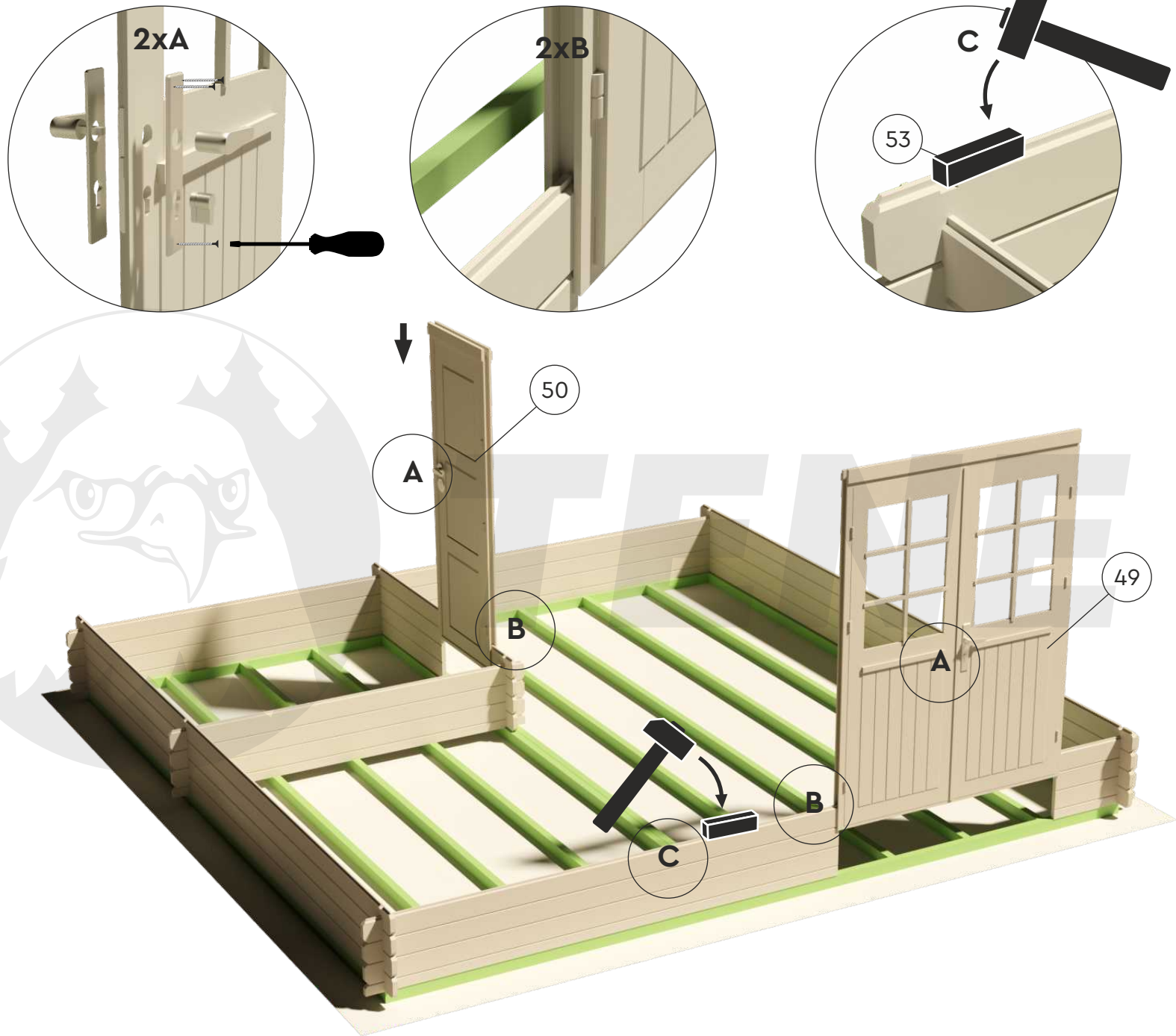

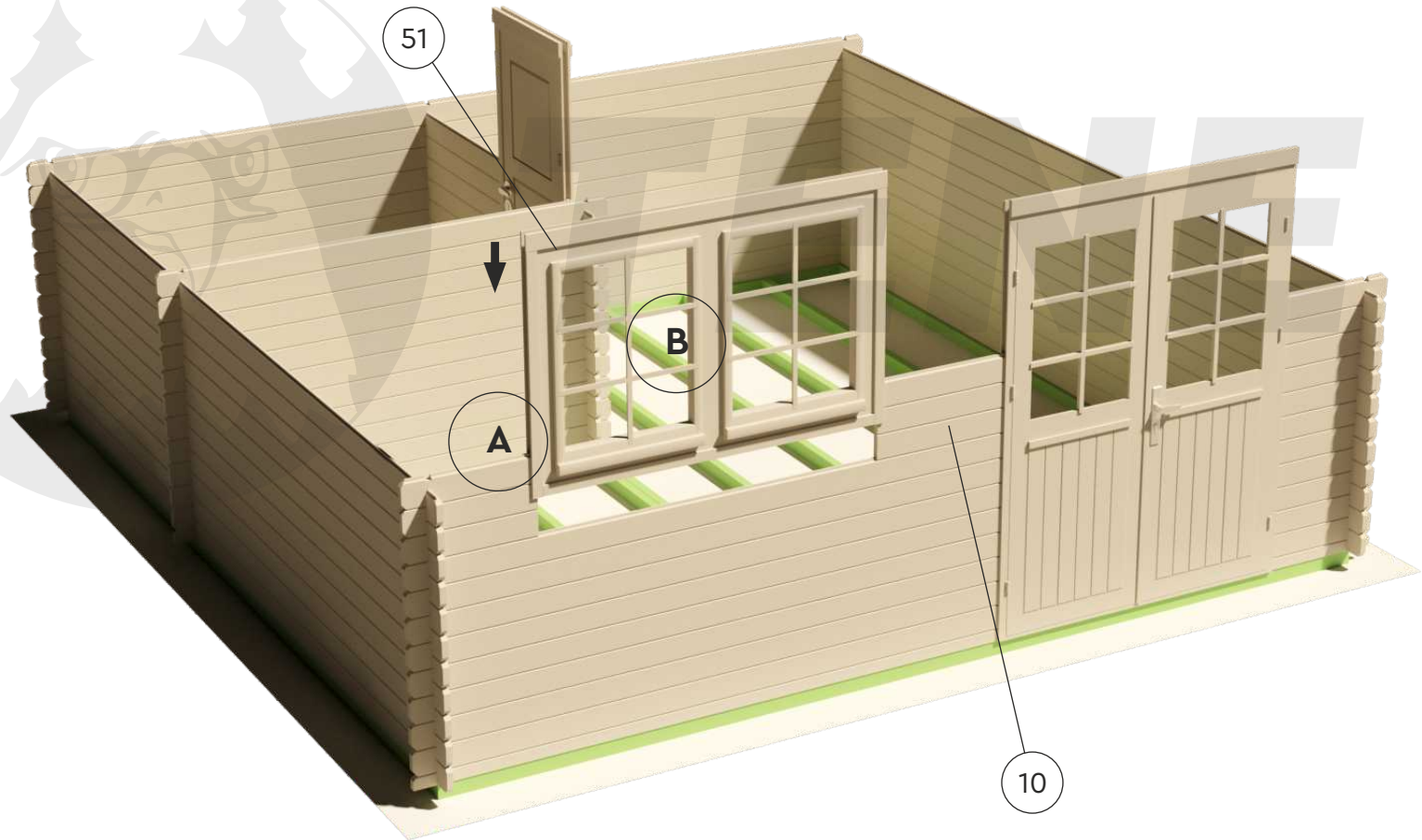
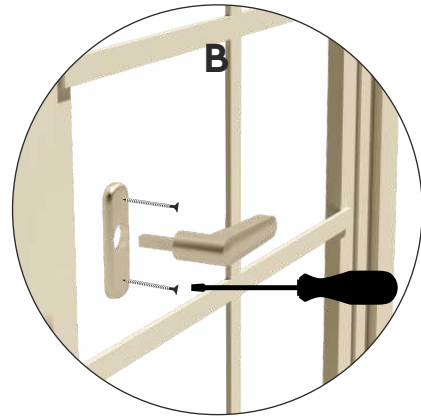
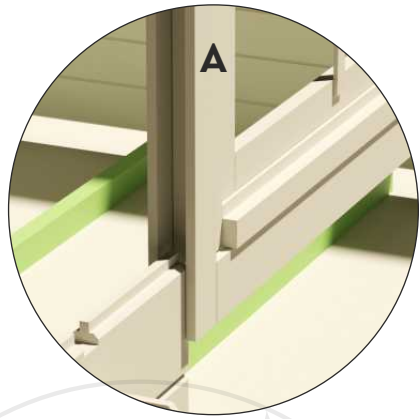



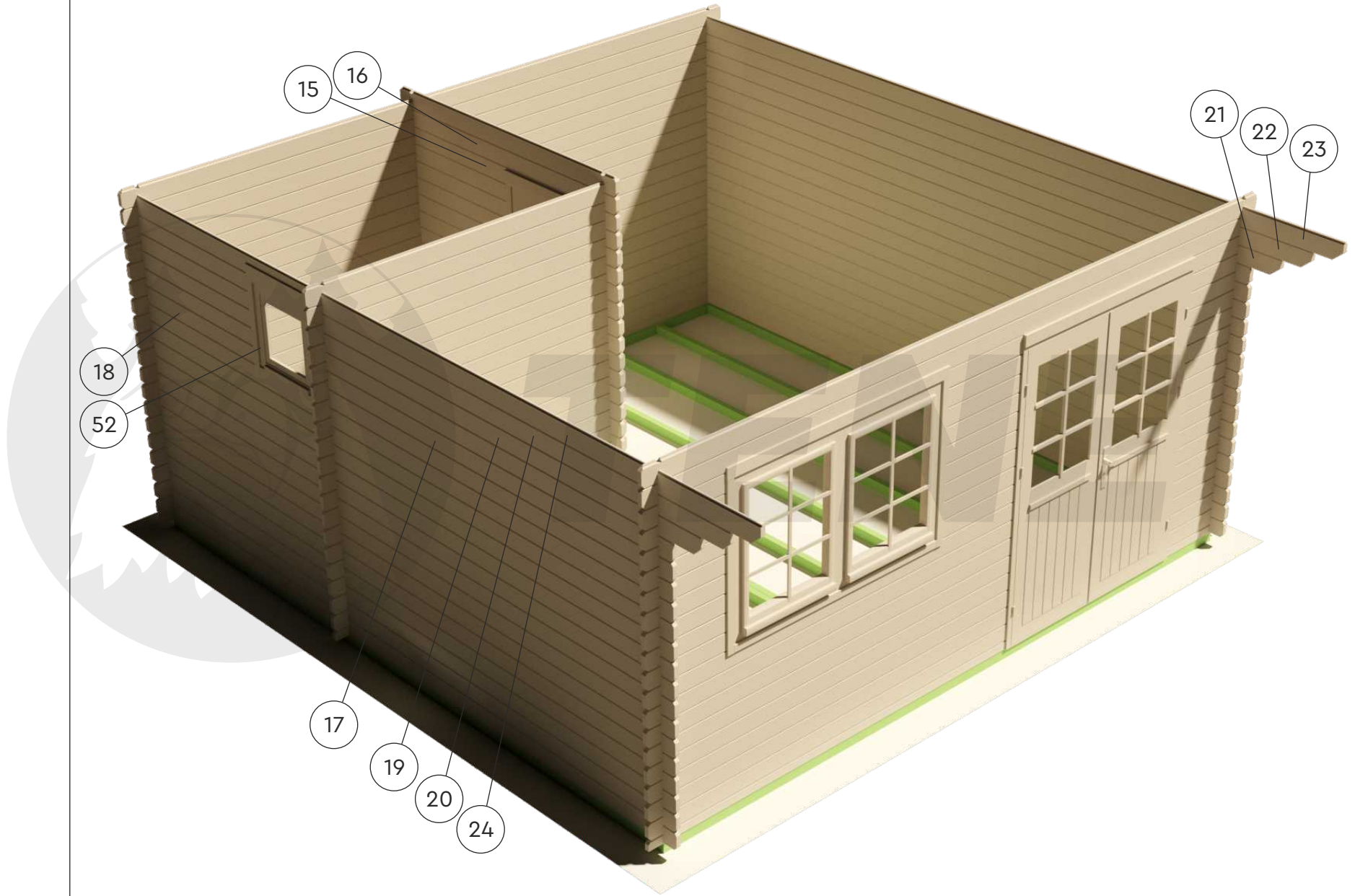

# RAMSI 28

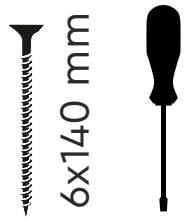
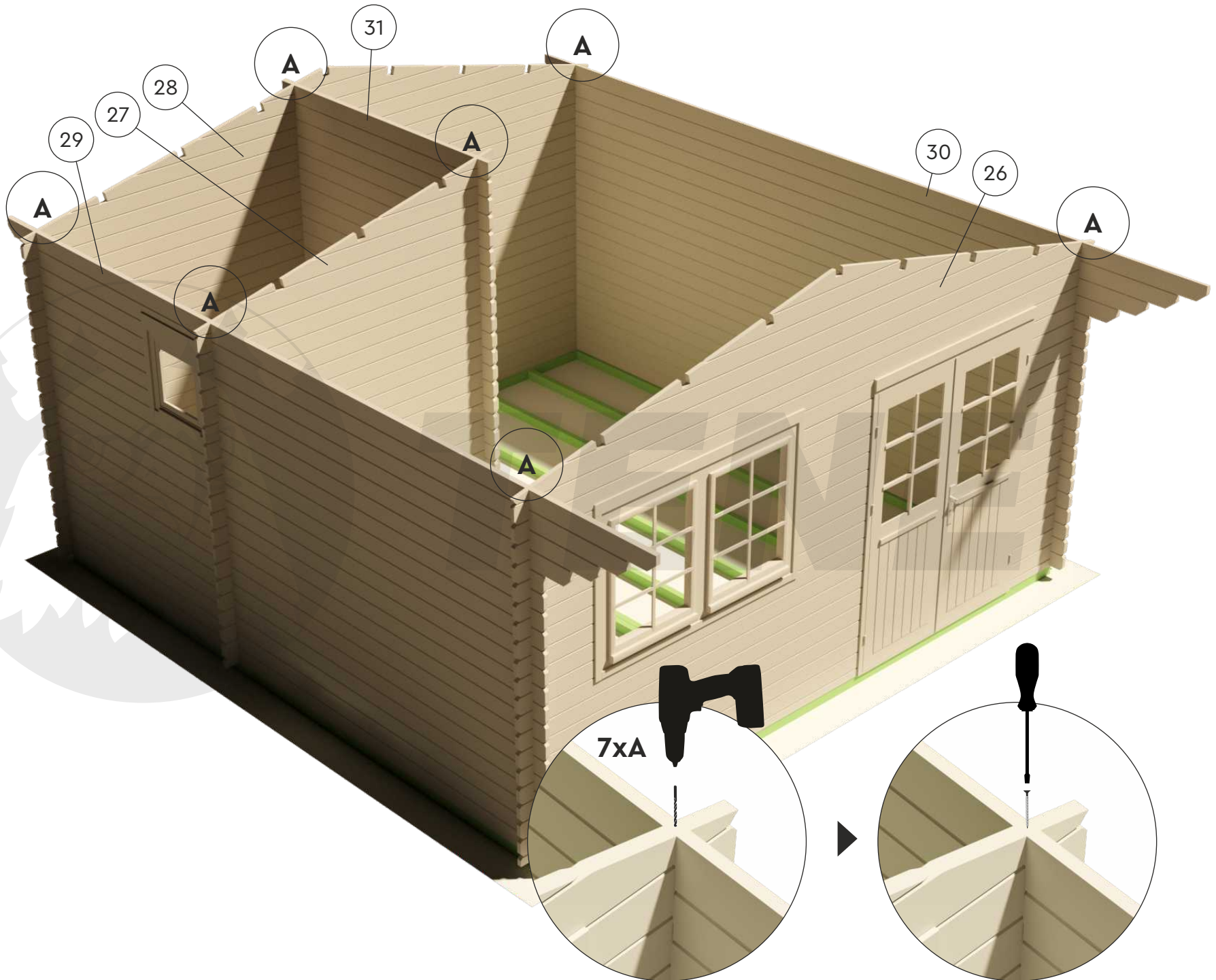



# RAMSI 28

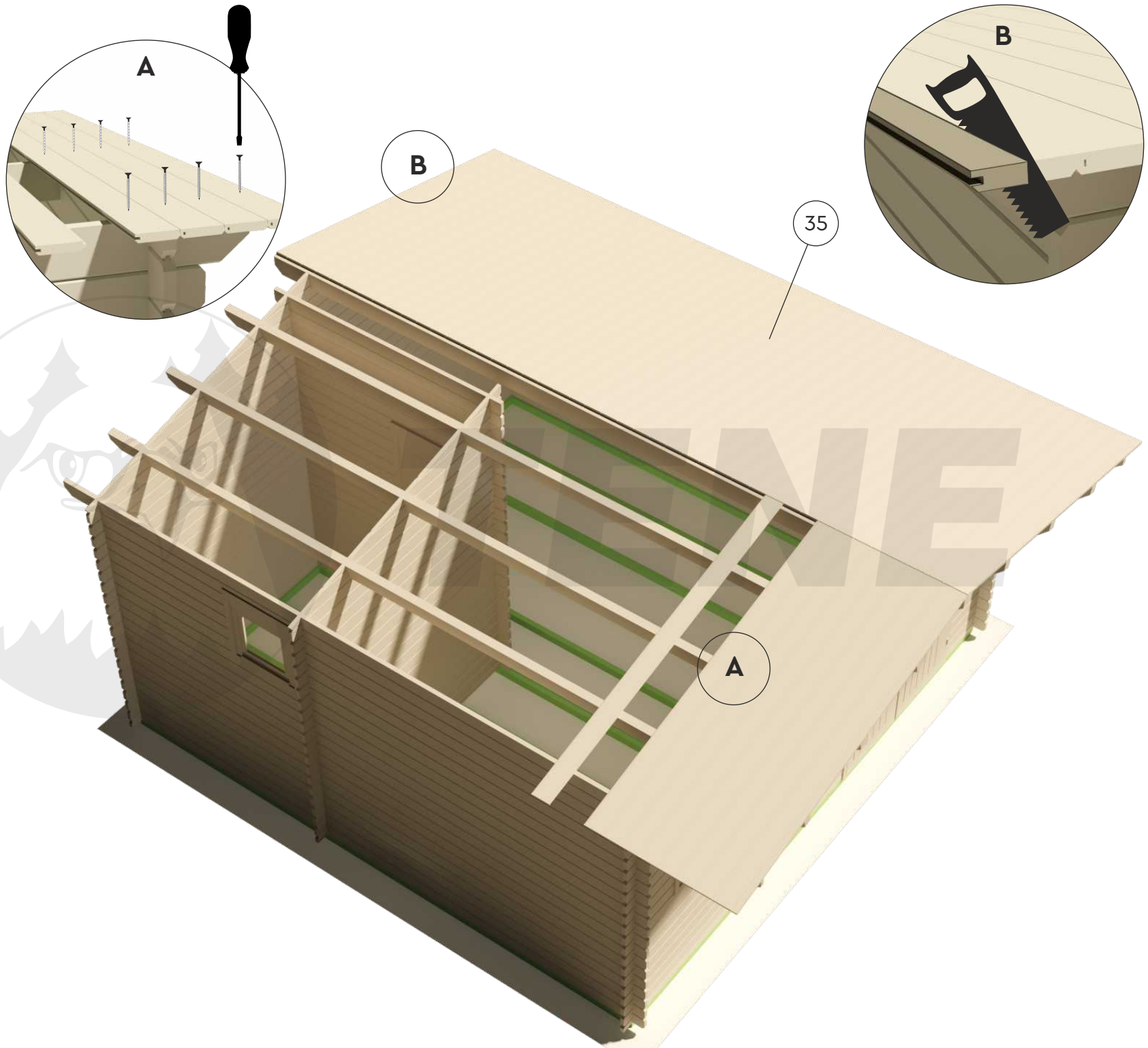

4x50 mm



# RAMSI 28

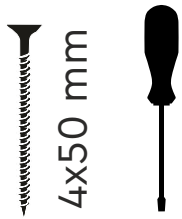
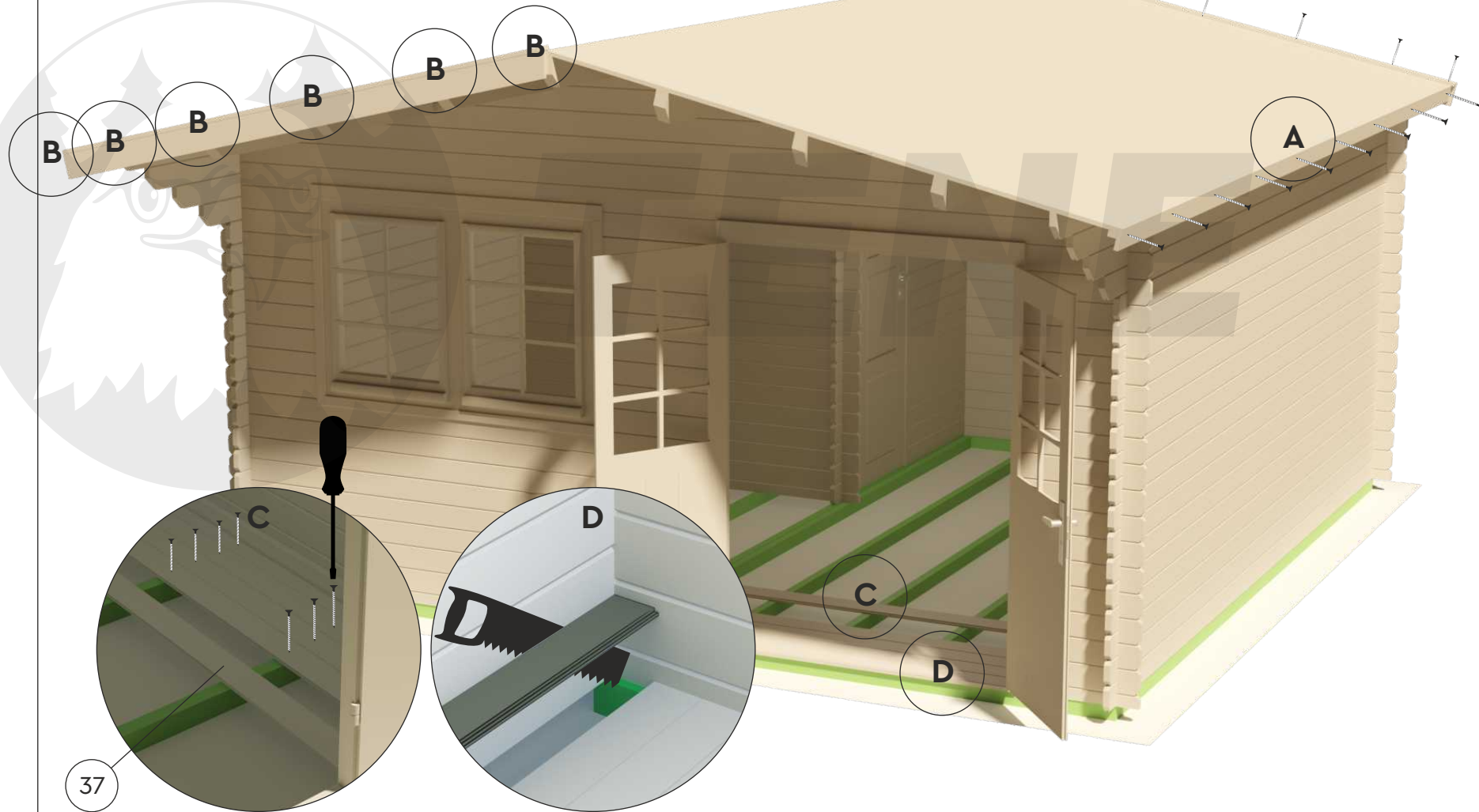
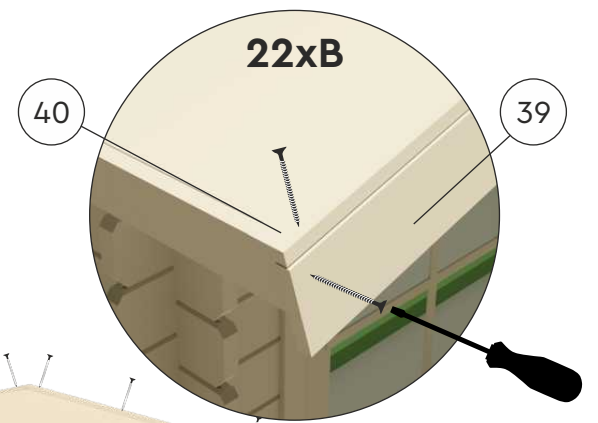
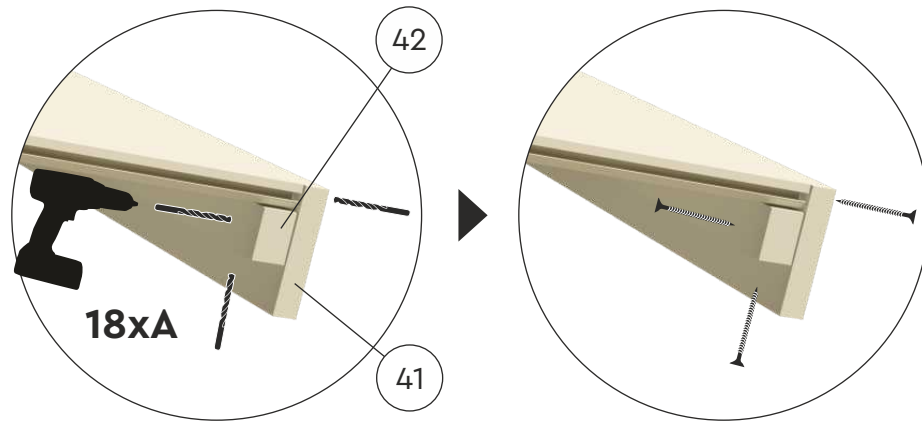

# RAMSI 28

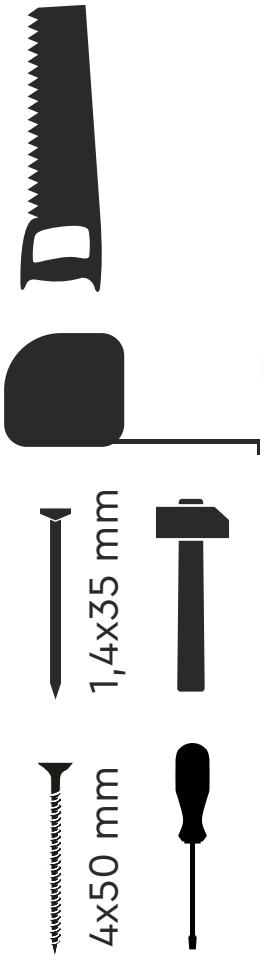
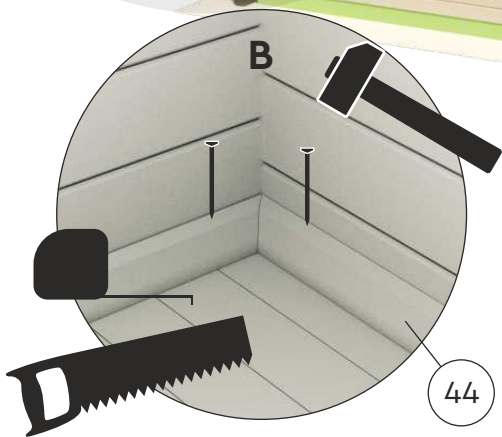
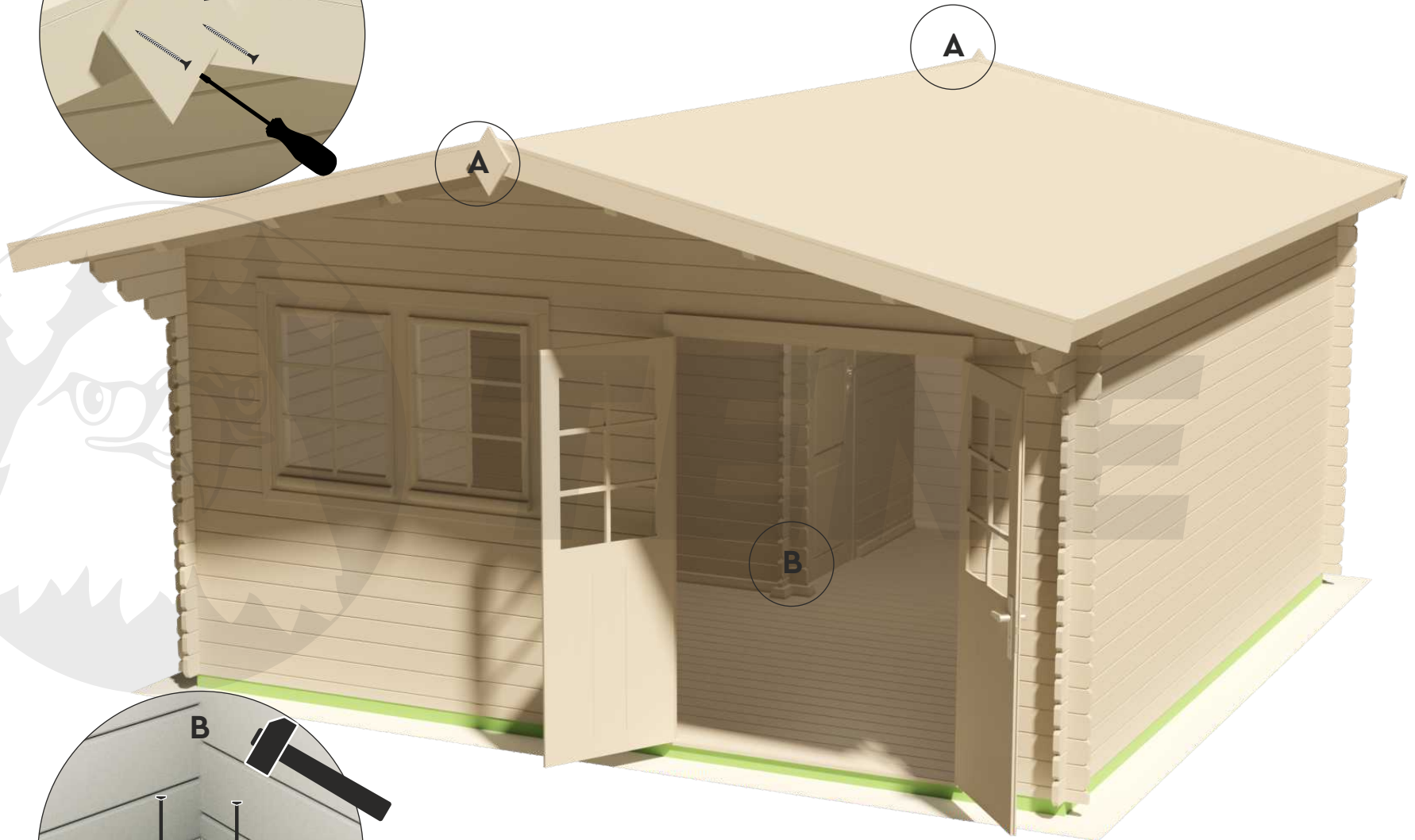
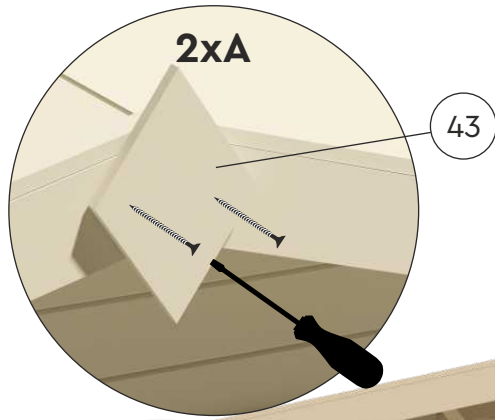

# RAMSI 28

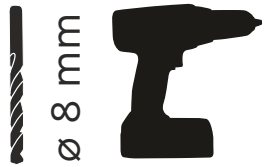
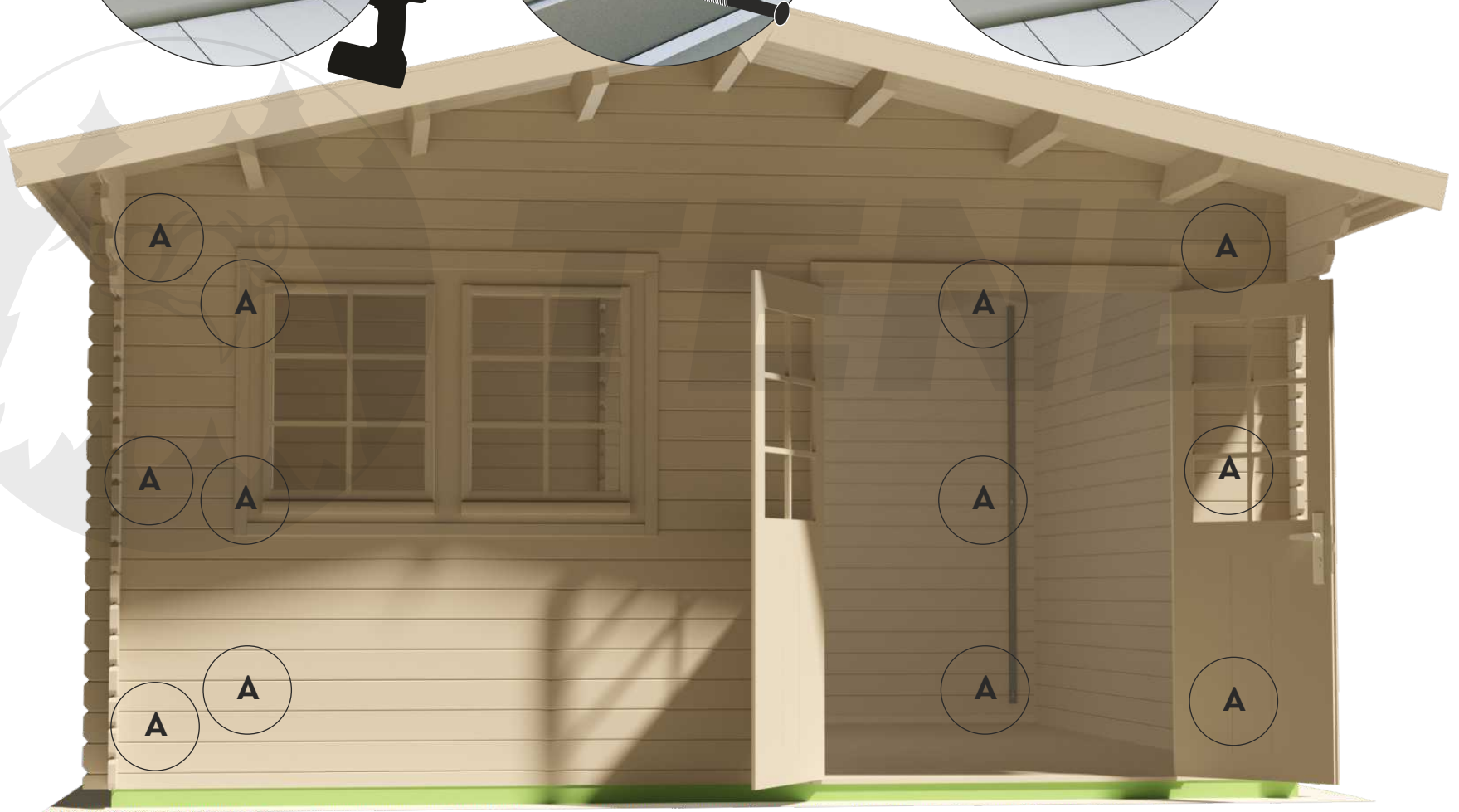
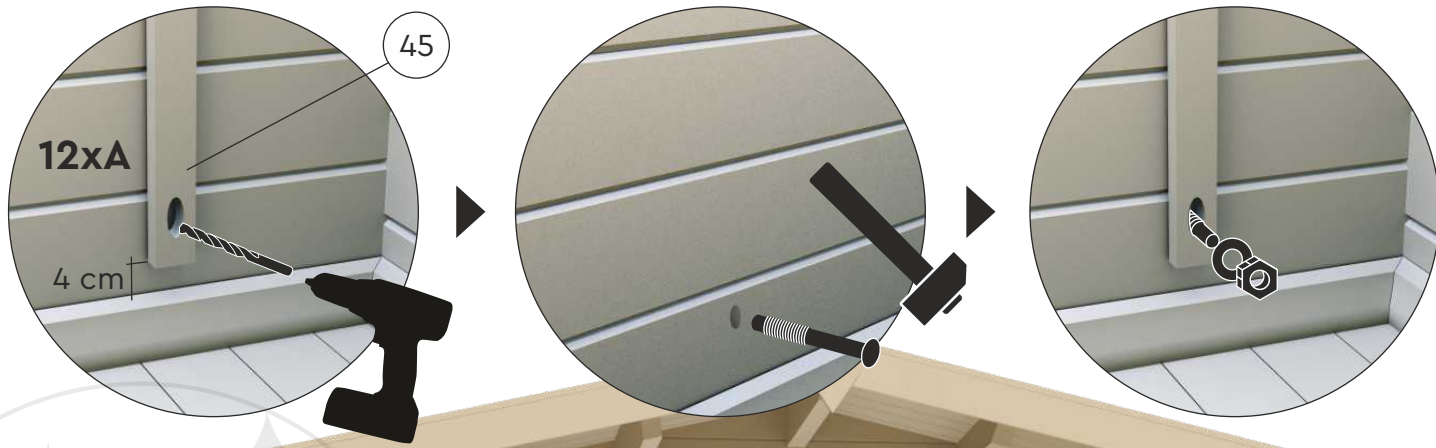

Ø 8 mm

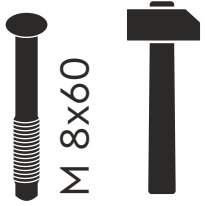

M 8x60

