

ENZO B 40

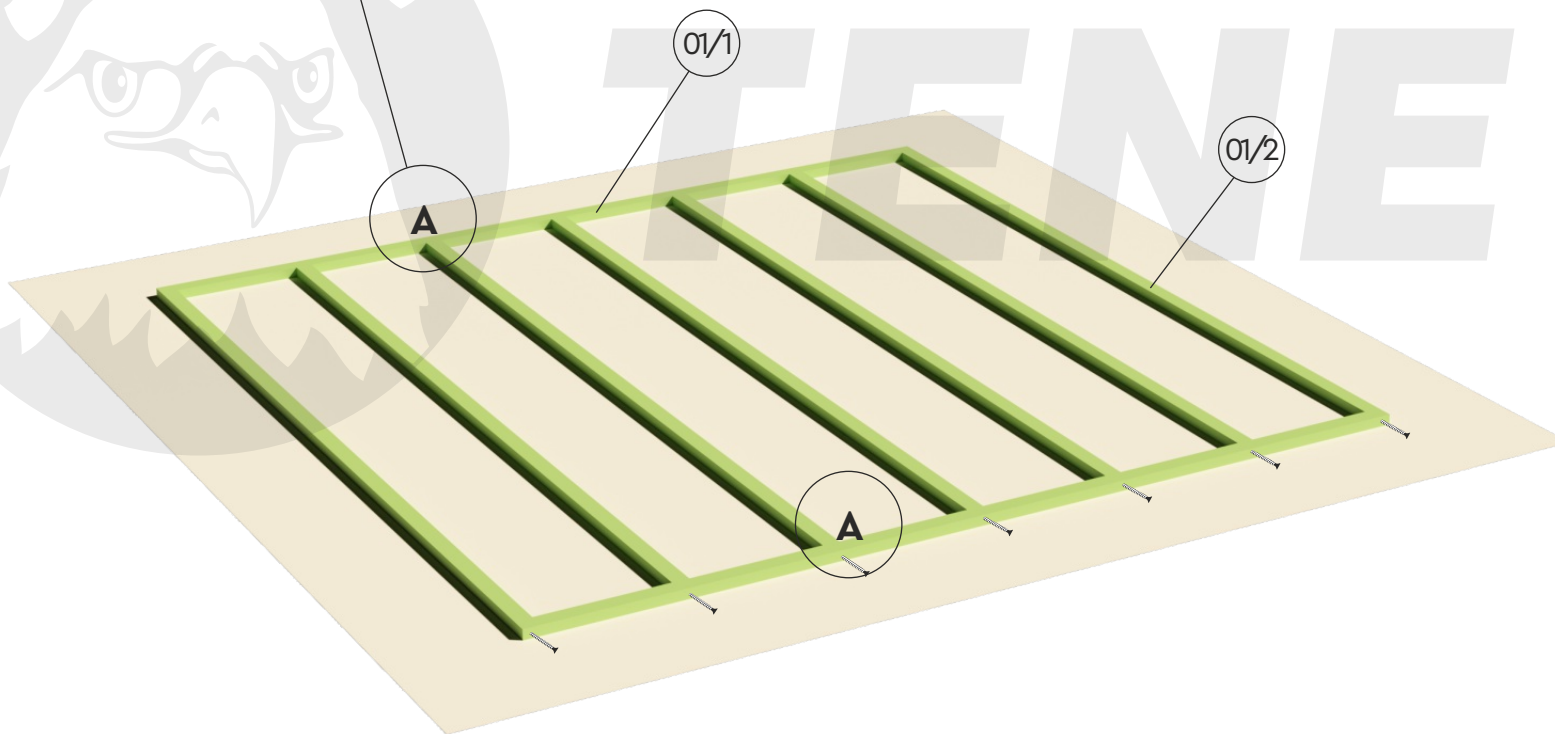

∅ 5 mm

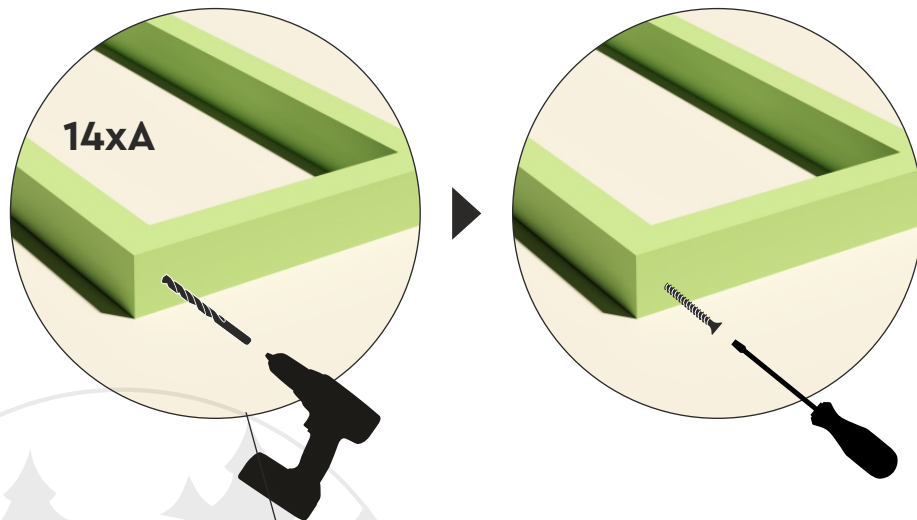
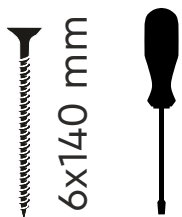

6x140 mm

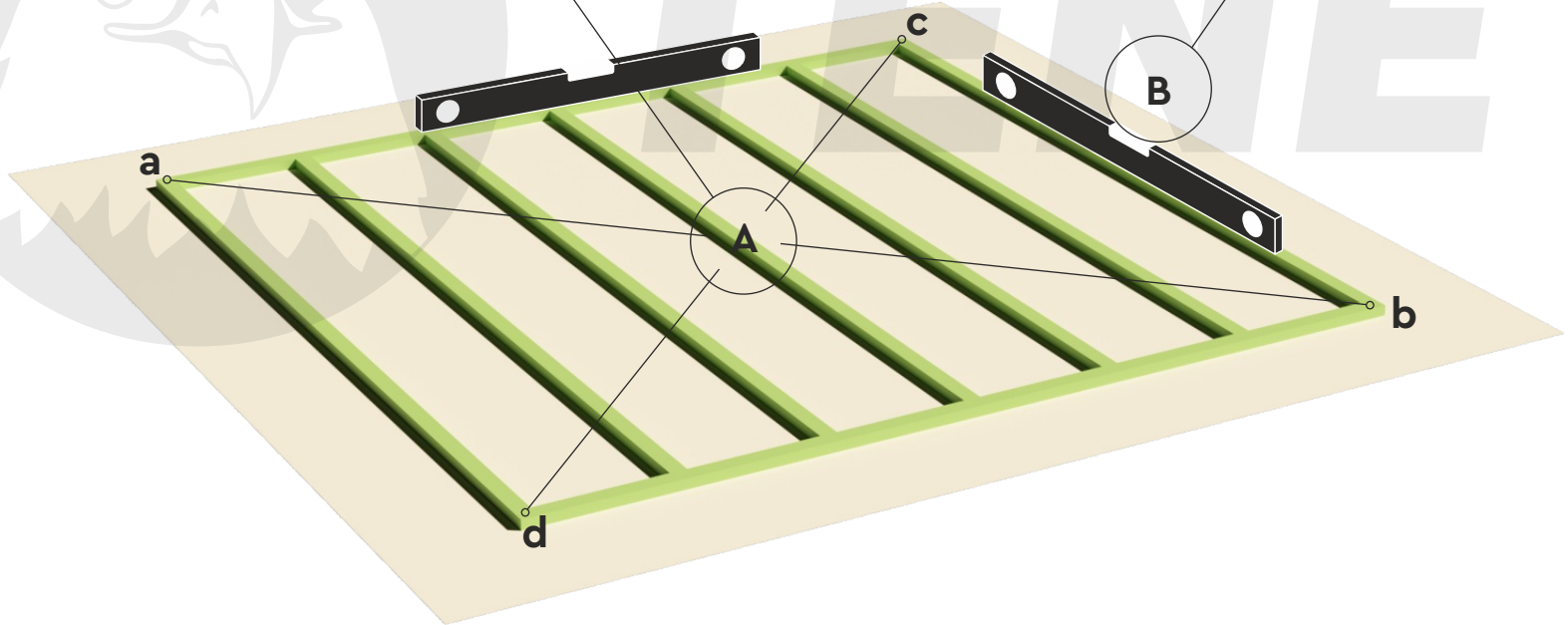
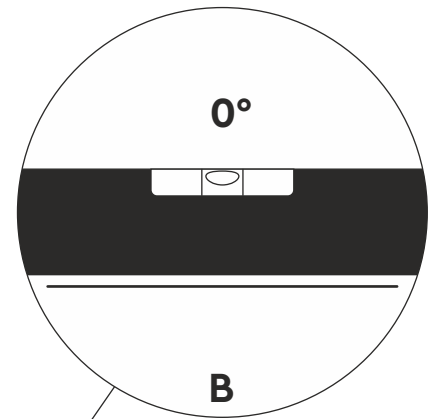
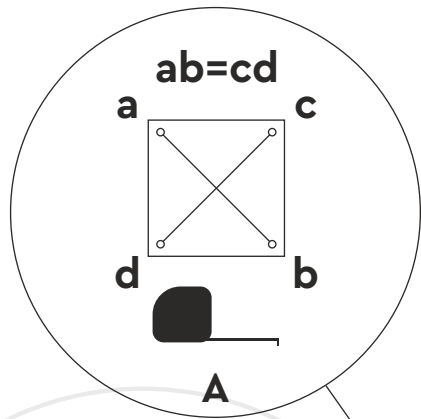

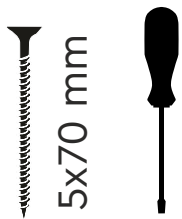
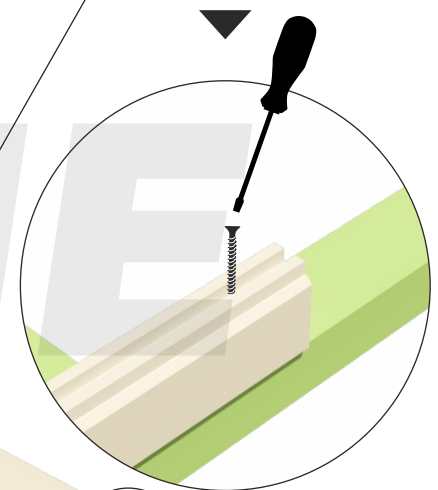
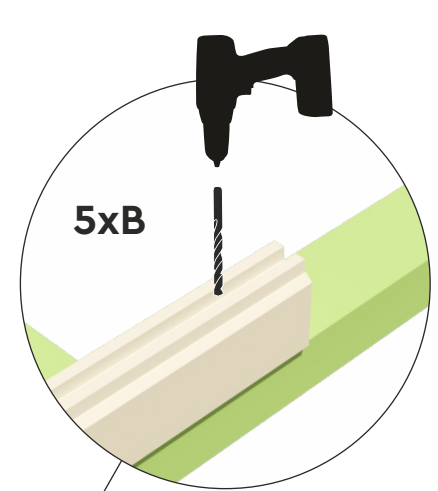
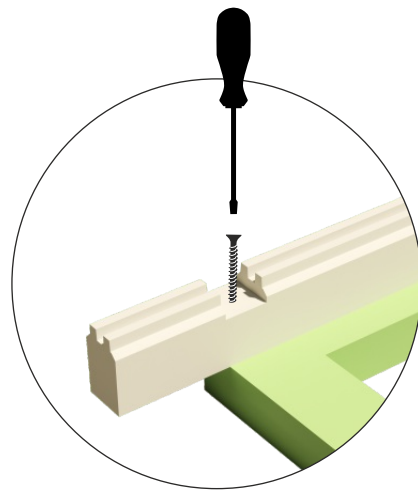
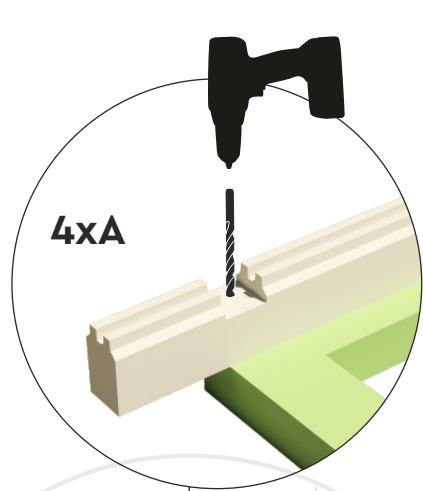
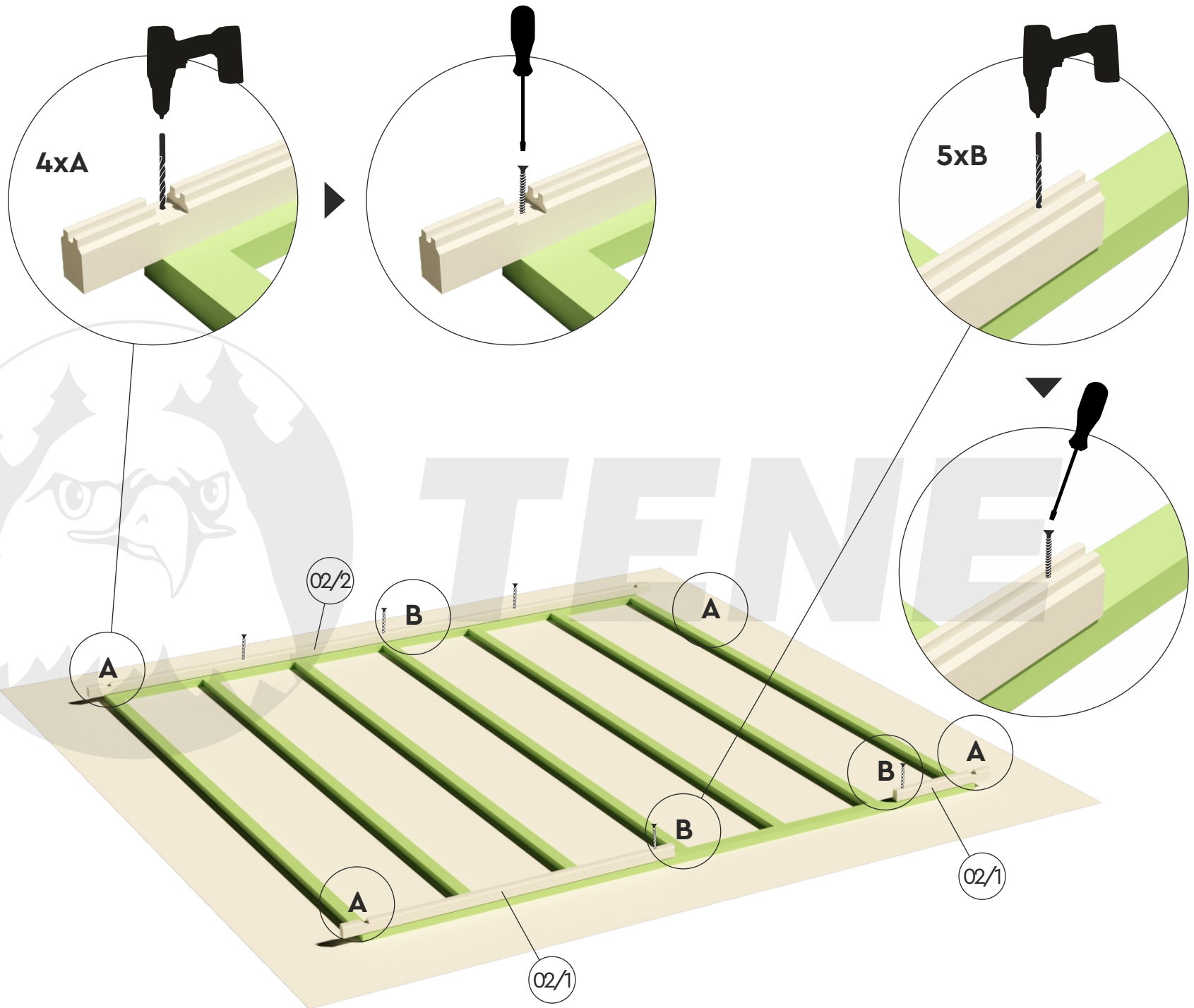

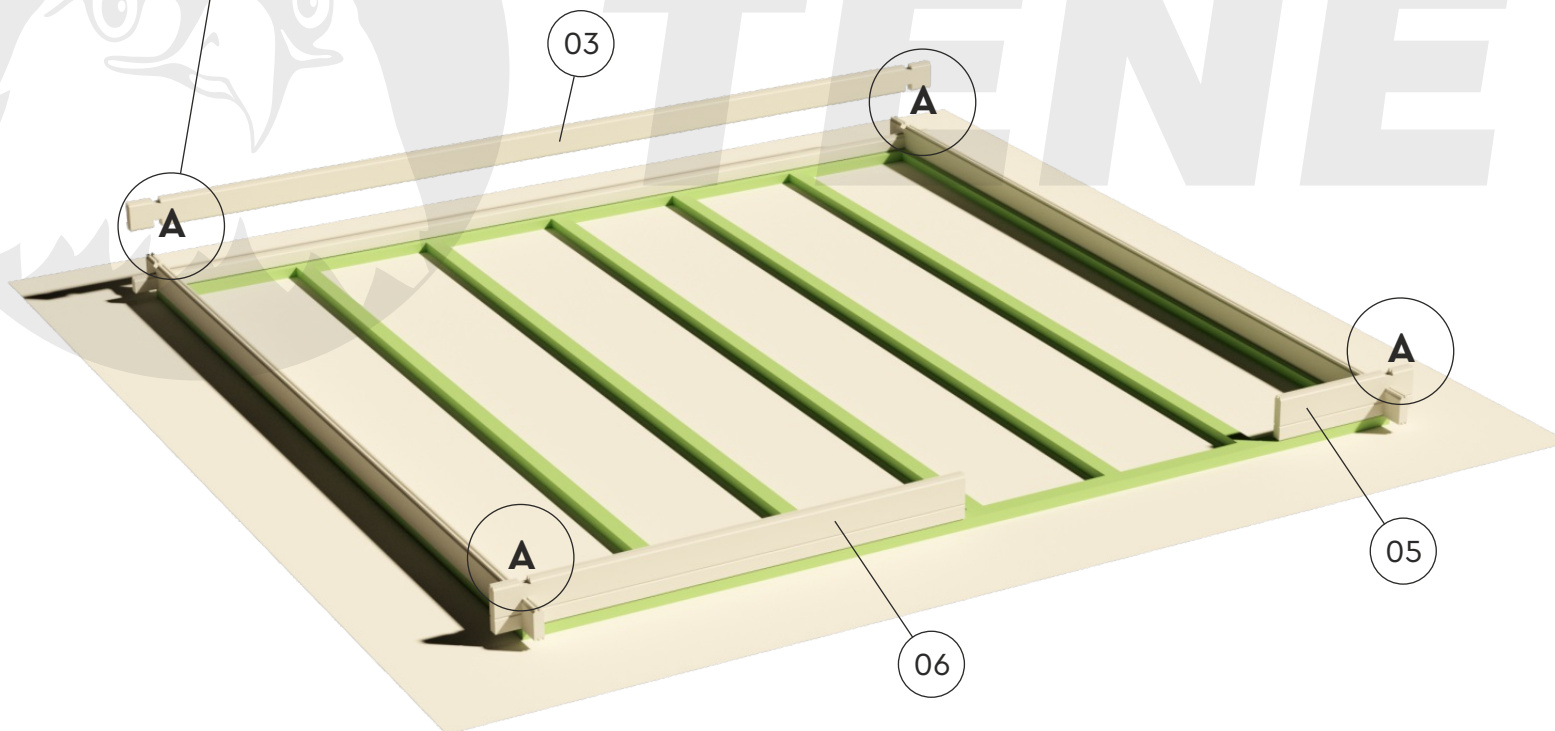
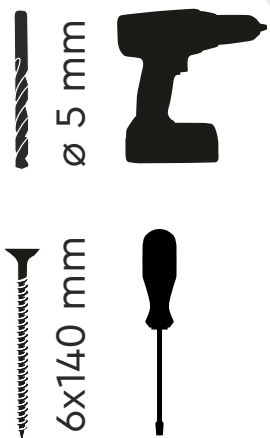
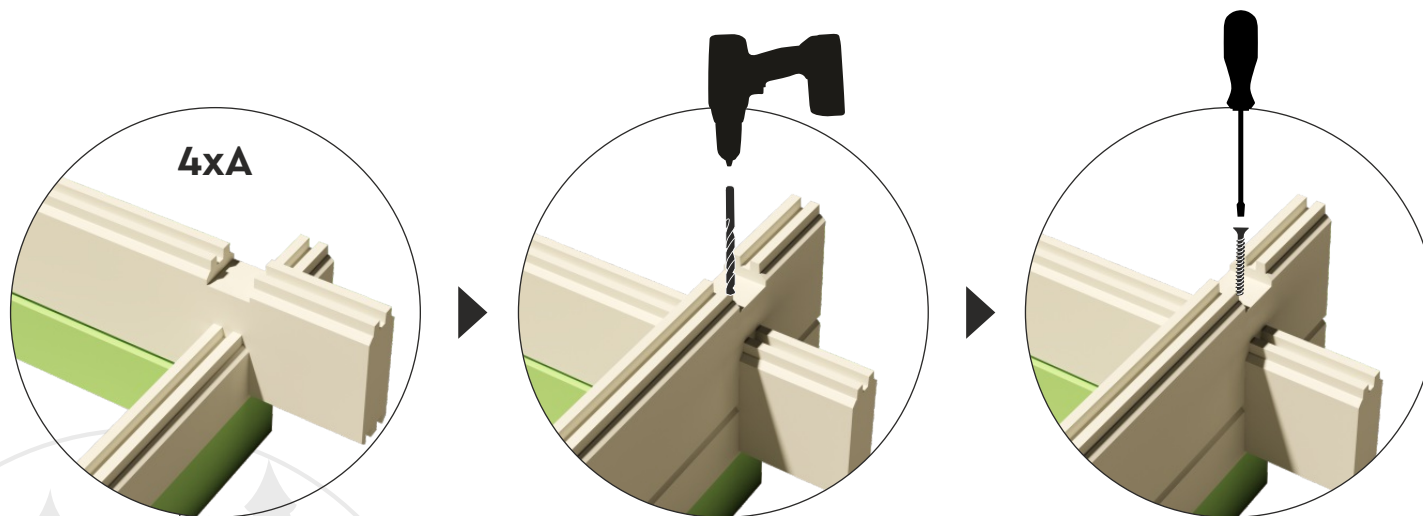

ENZO B 40

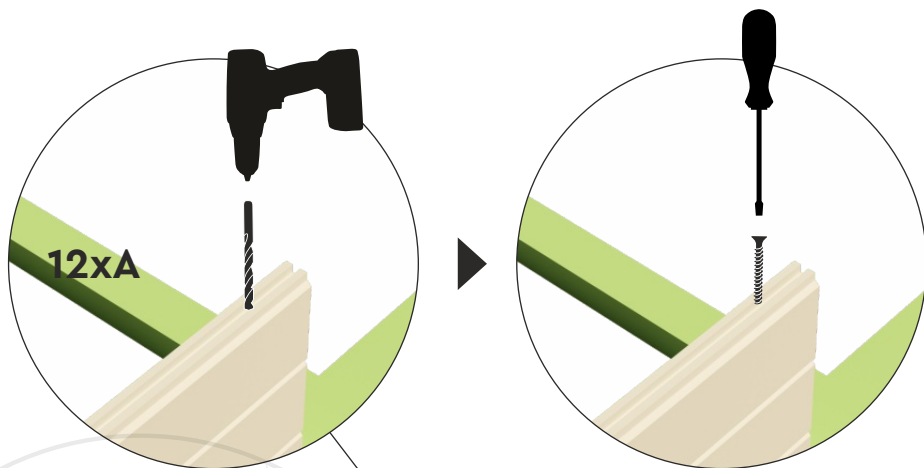

Ø 5 mm

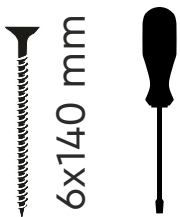

6x140 mm

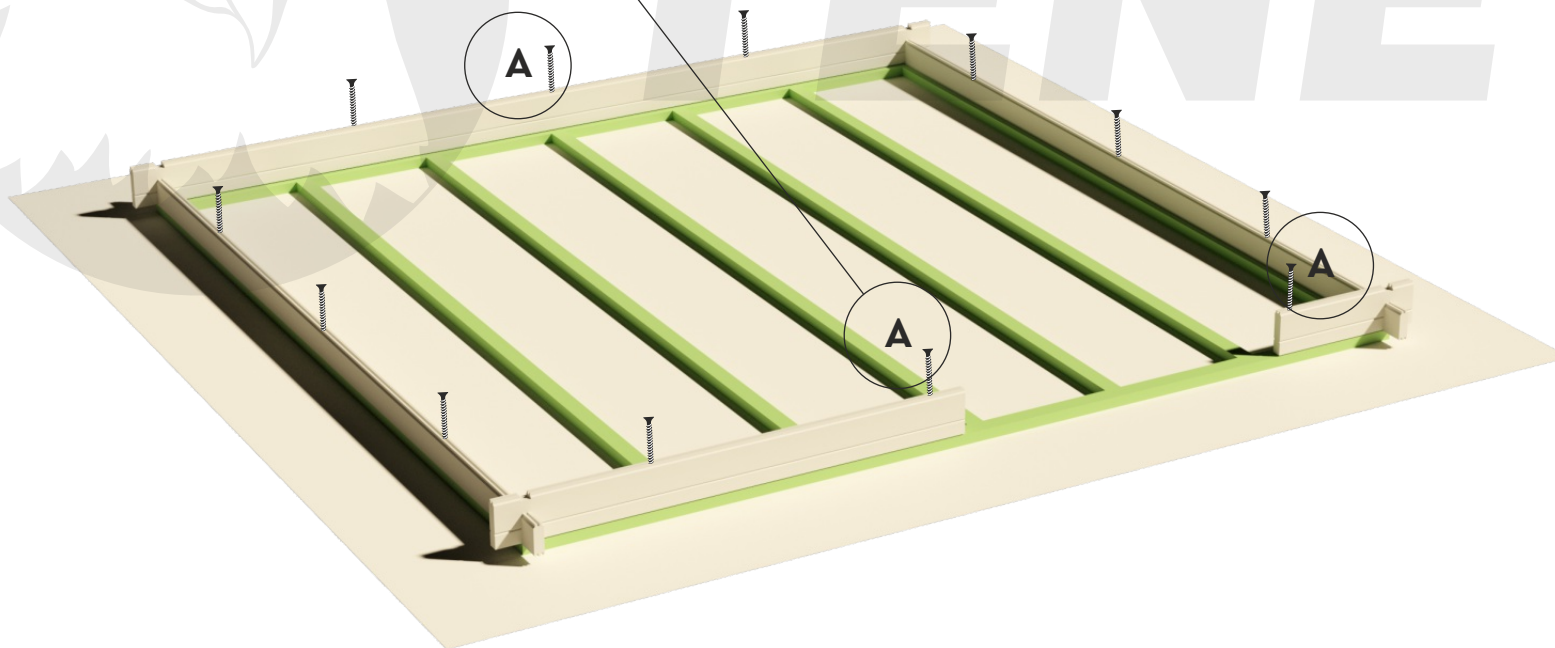

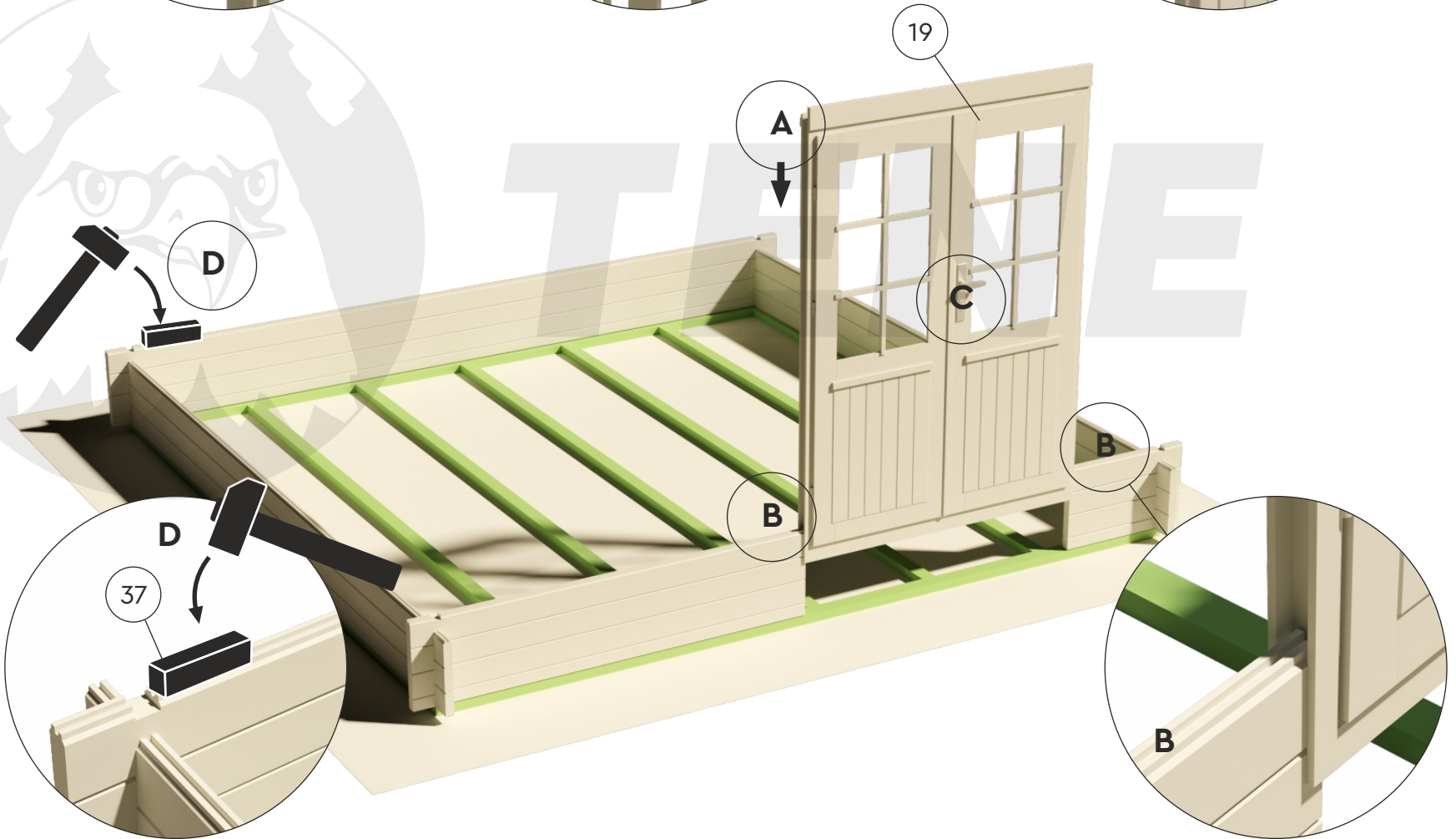
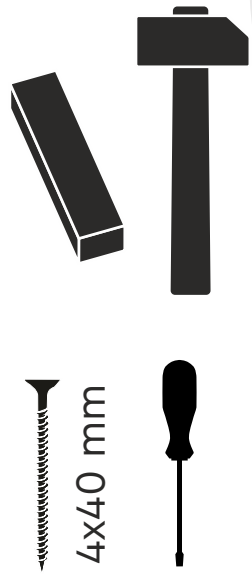
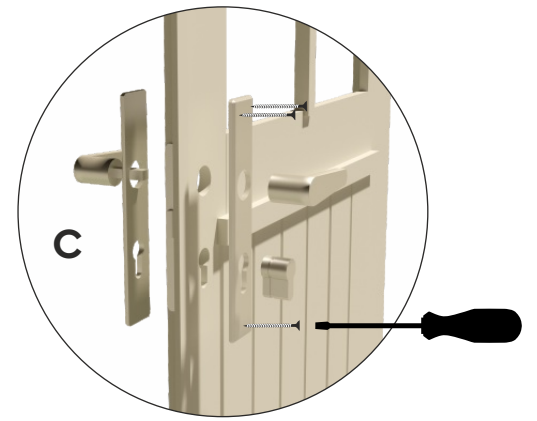
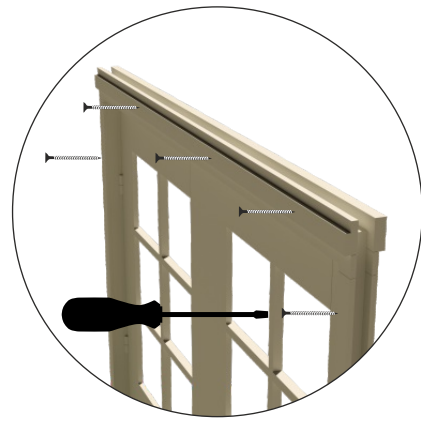
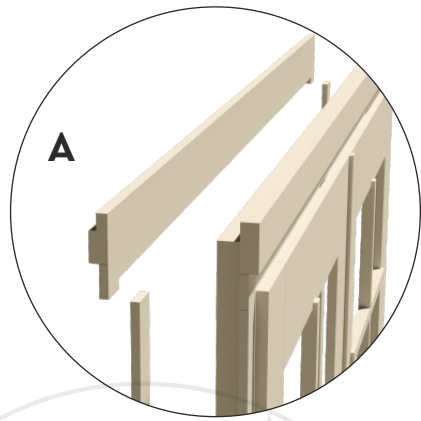

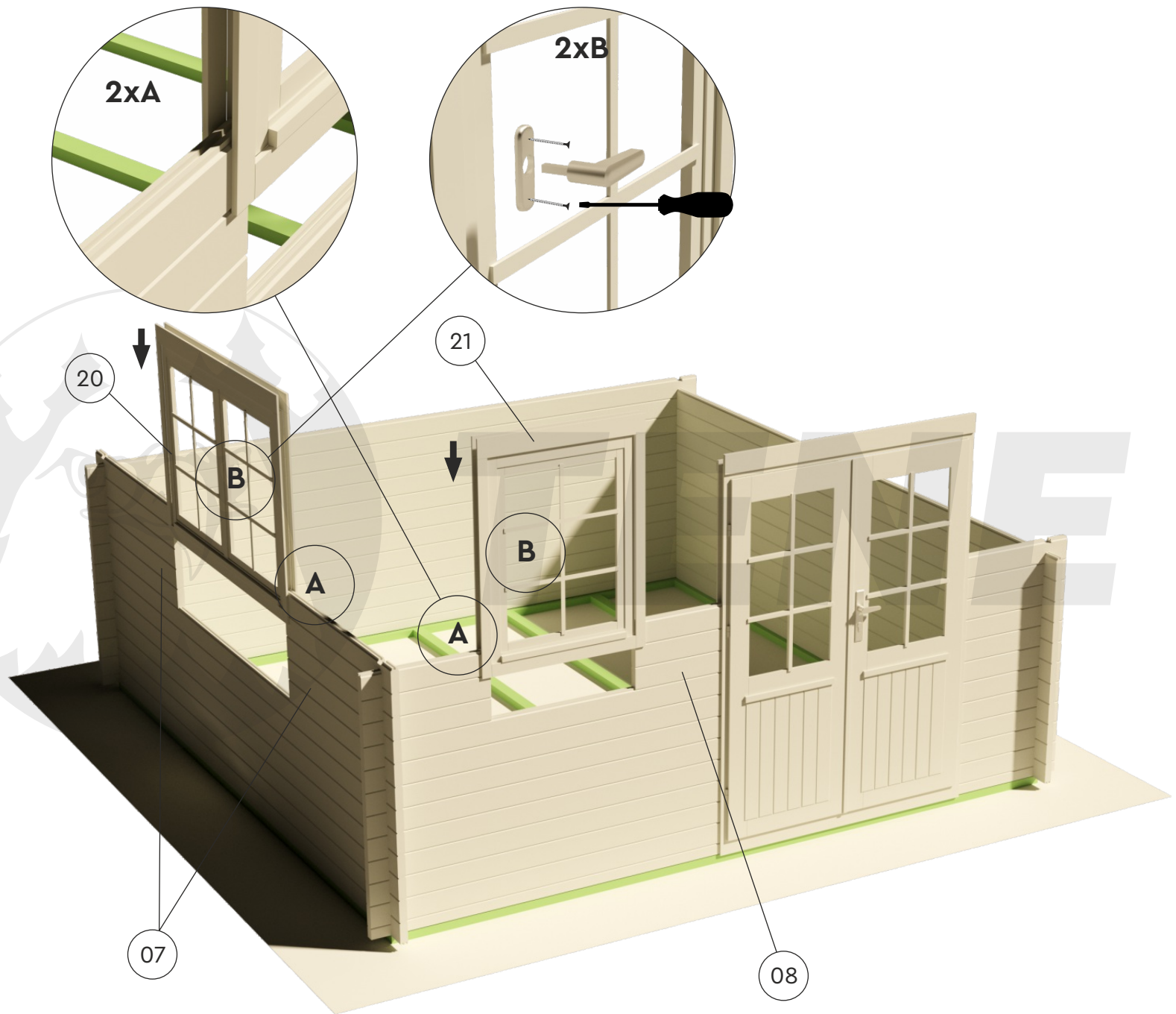

ENZO B 40

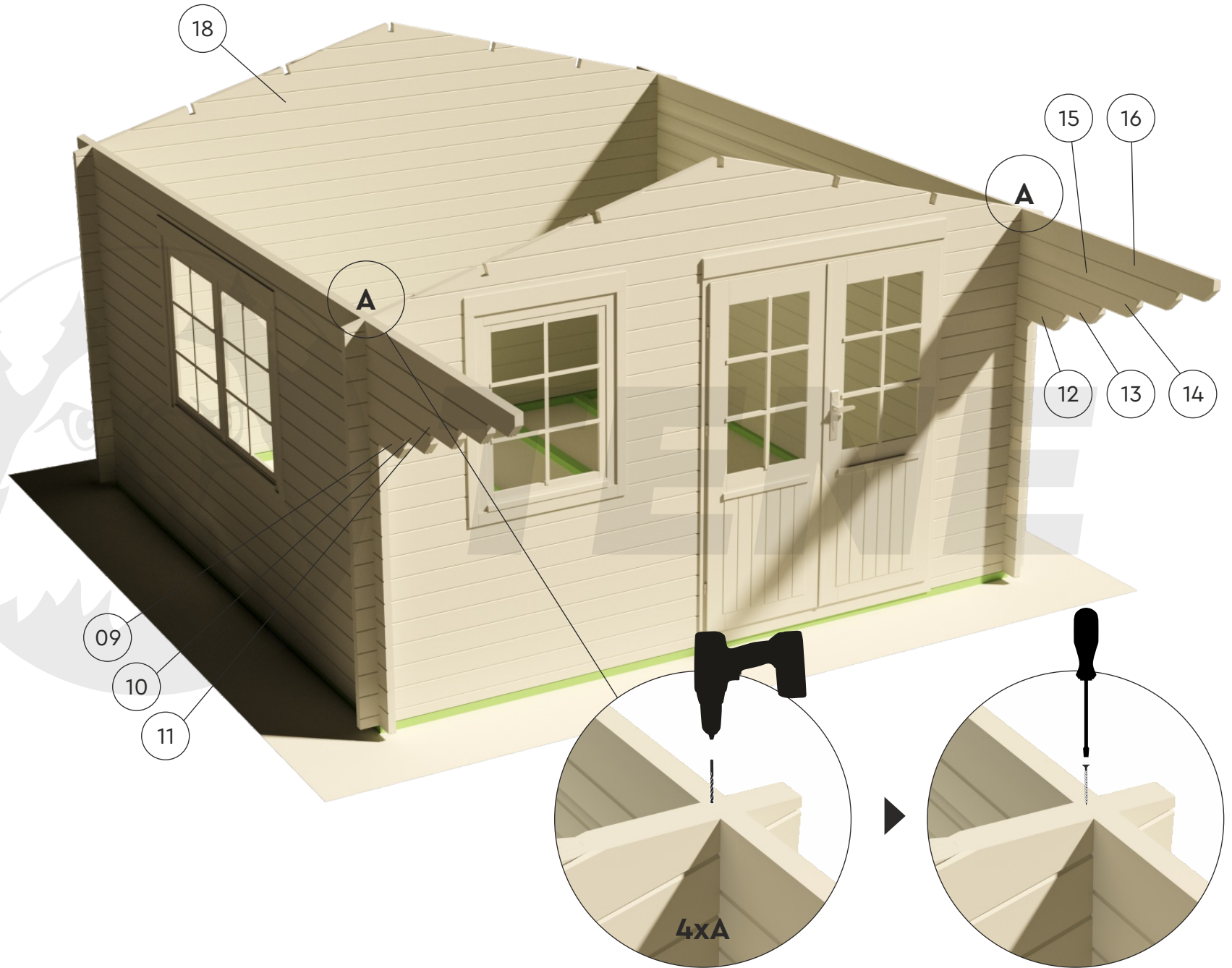

ENZO B 40

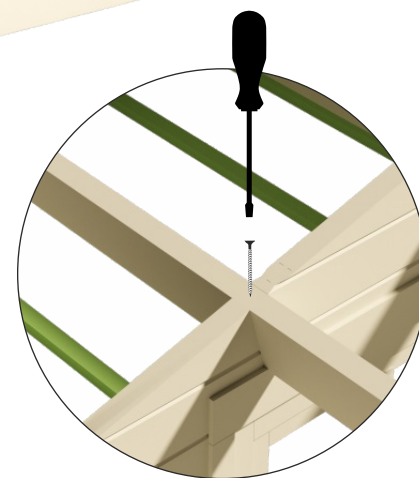
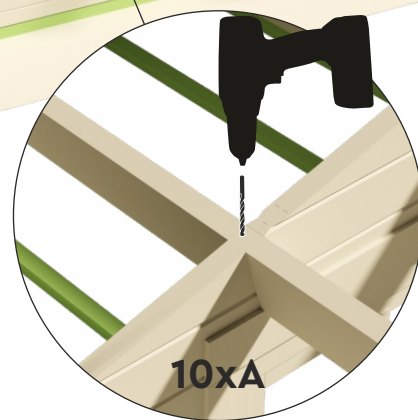
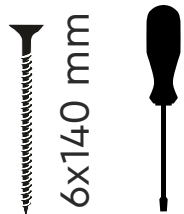
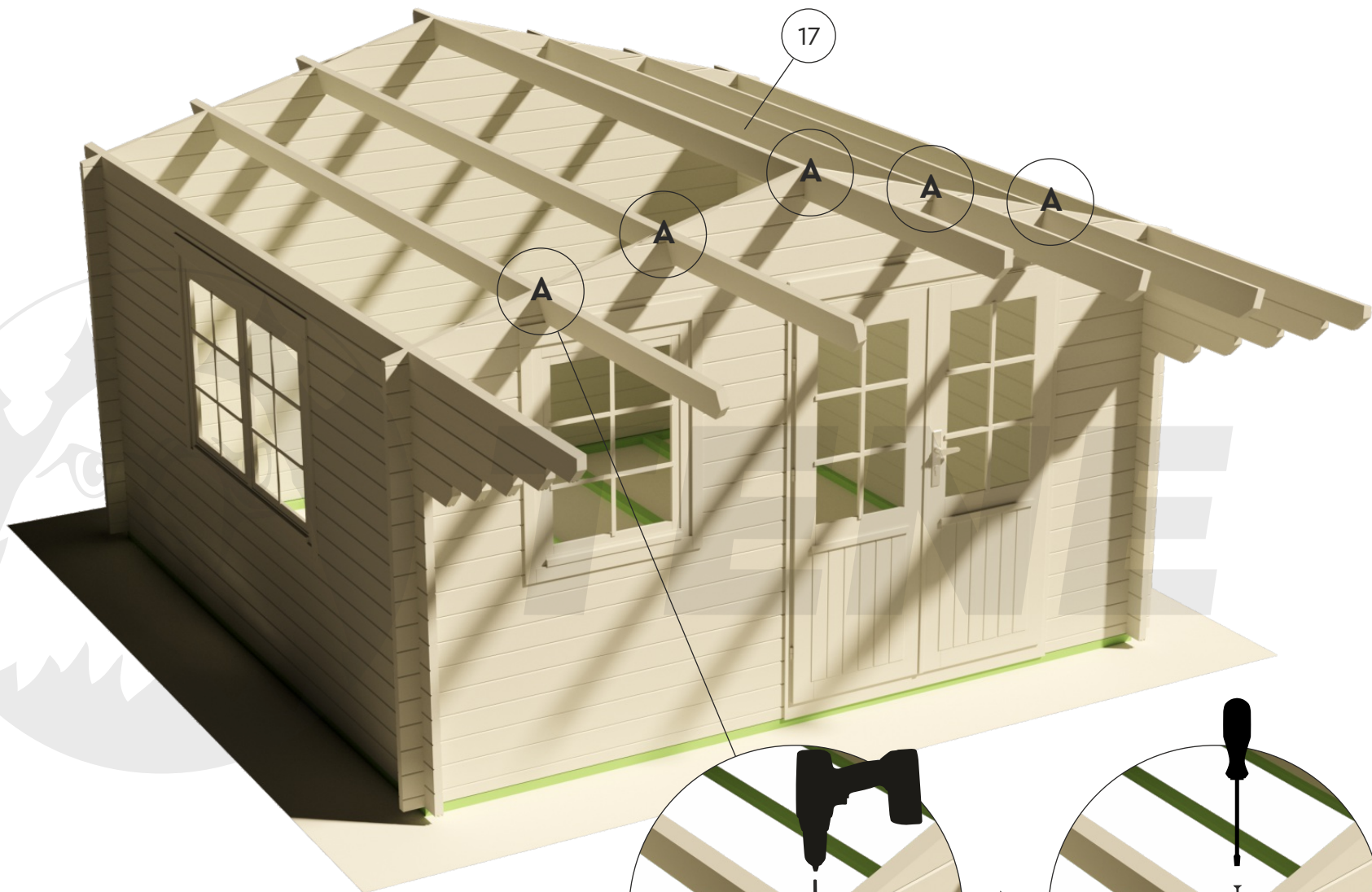

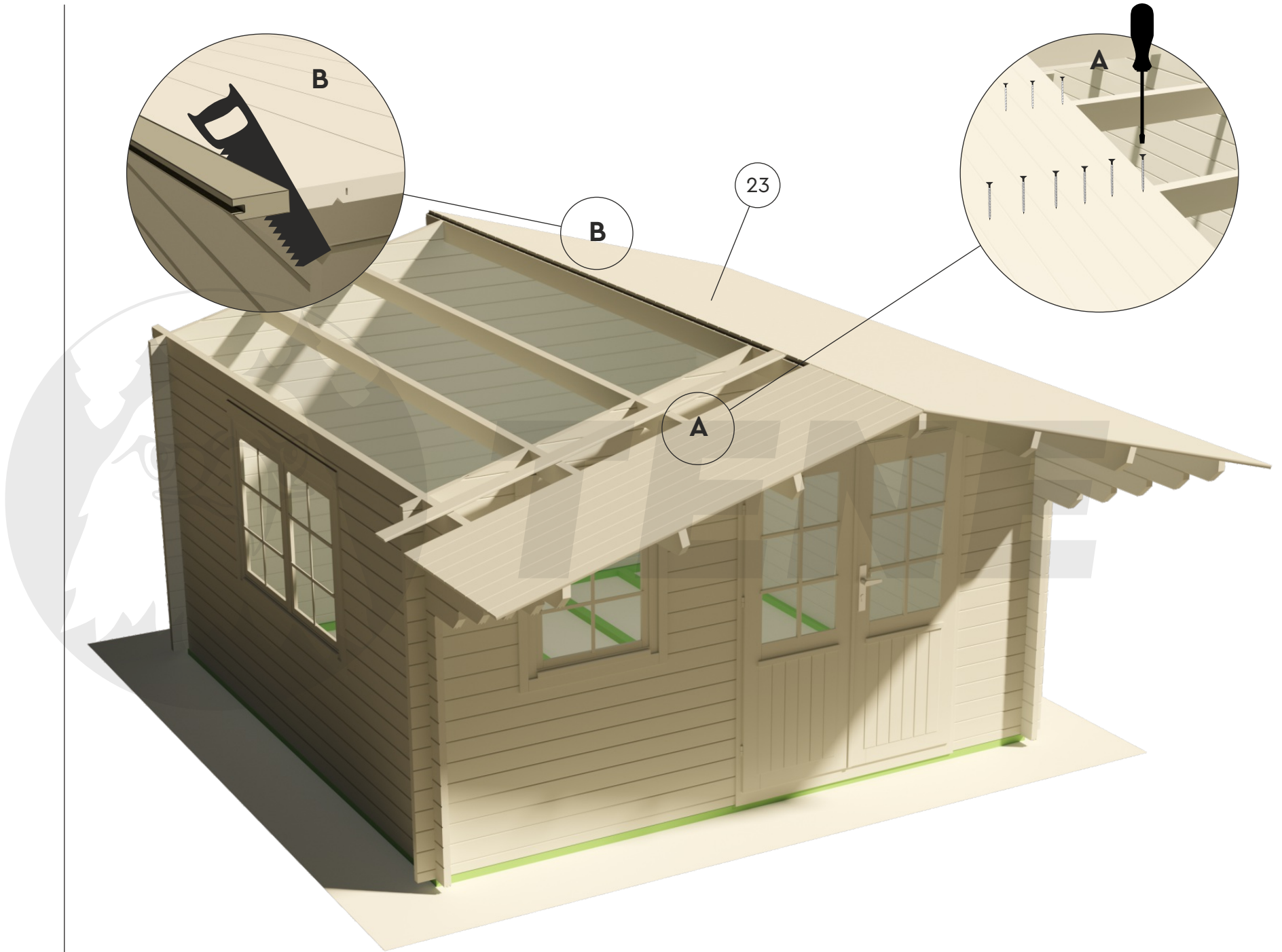
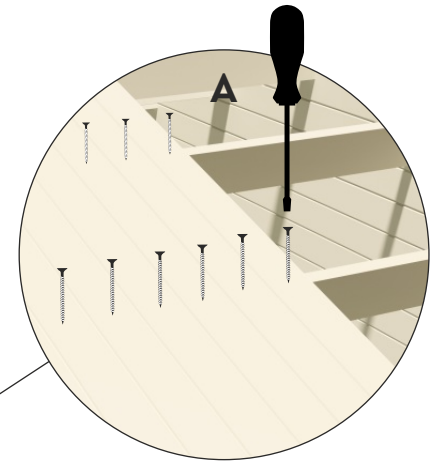
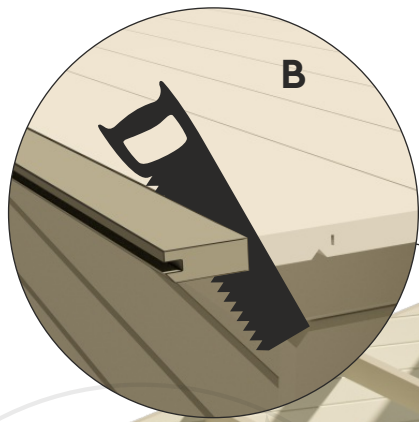

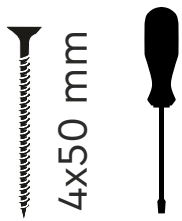
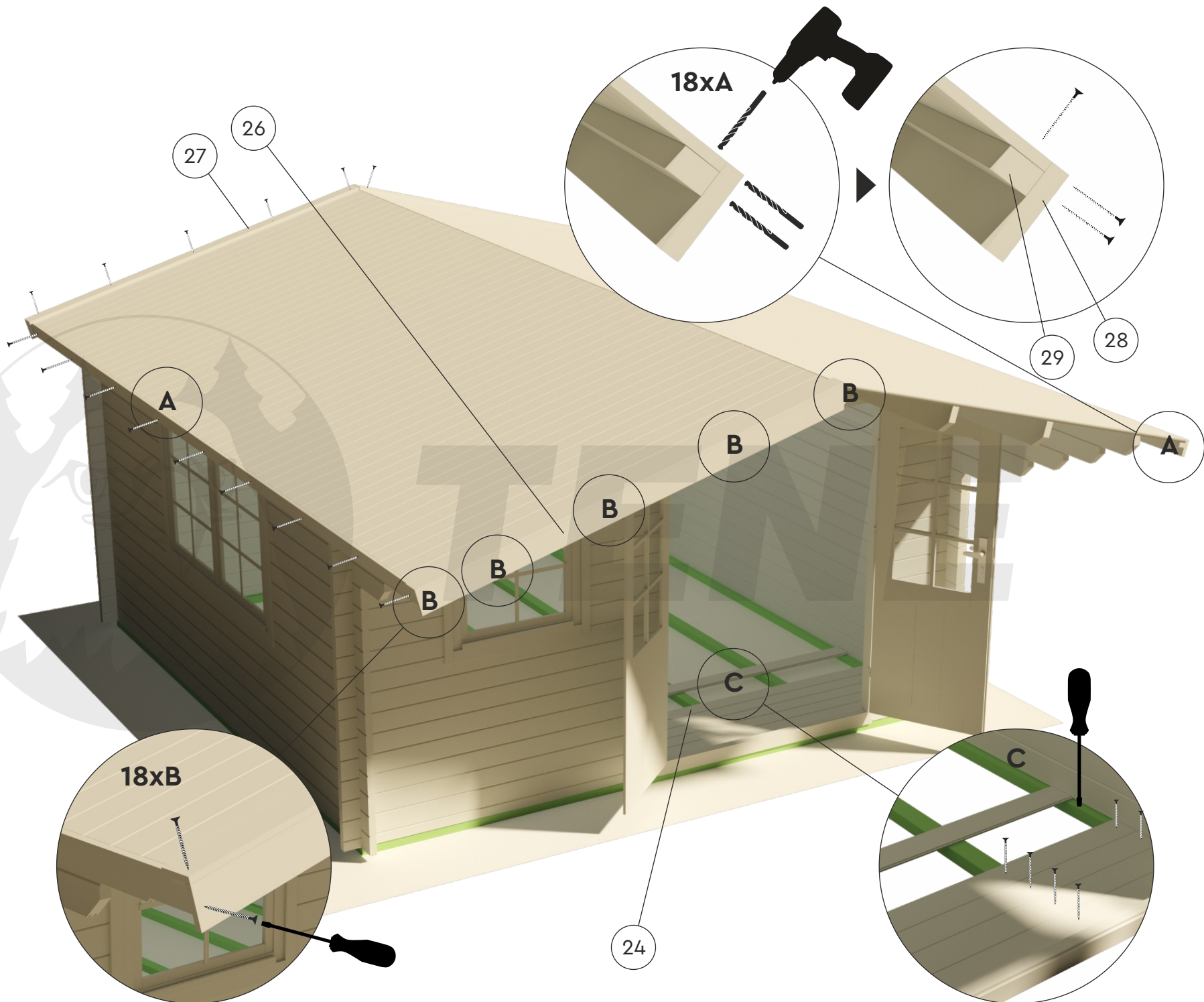

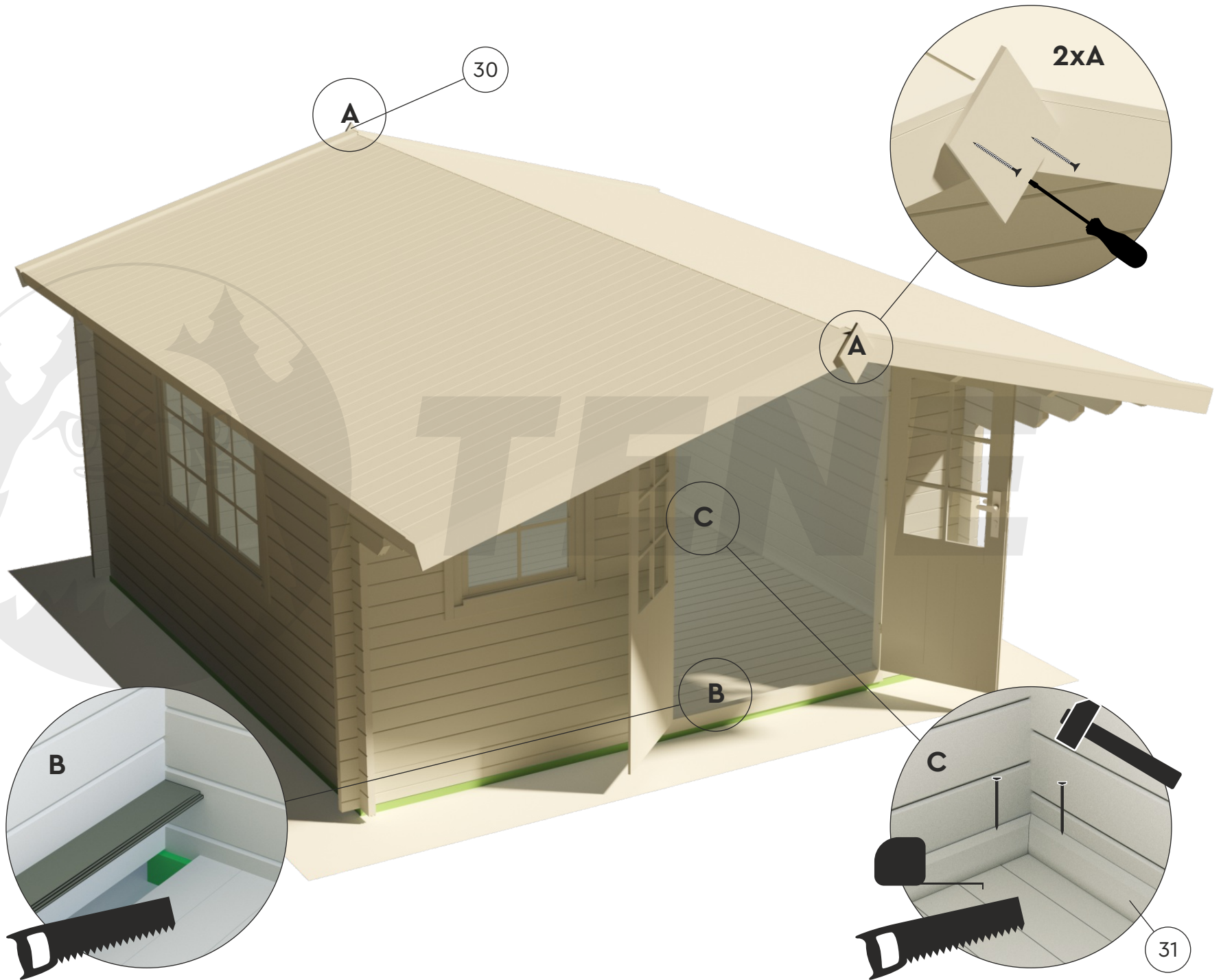
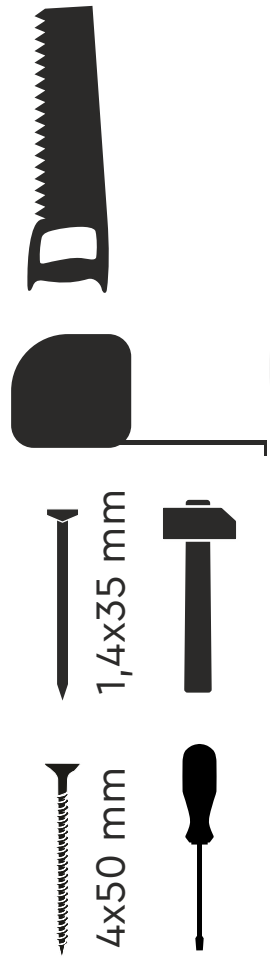

ENZO B 40

