

DANIEL 40

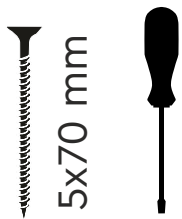

DANIEL 40

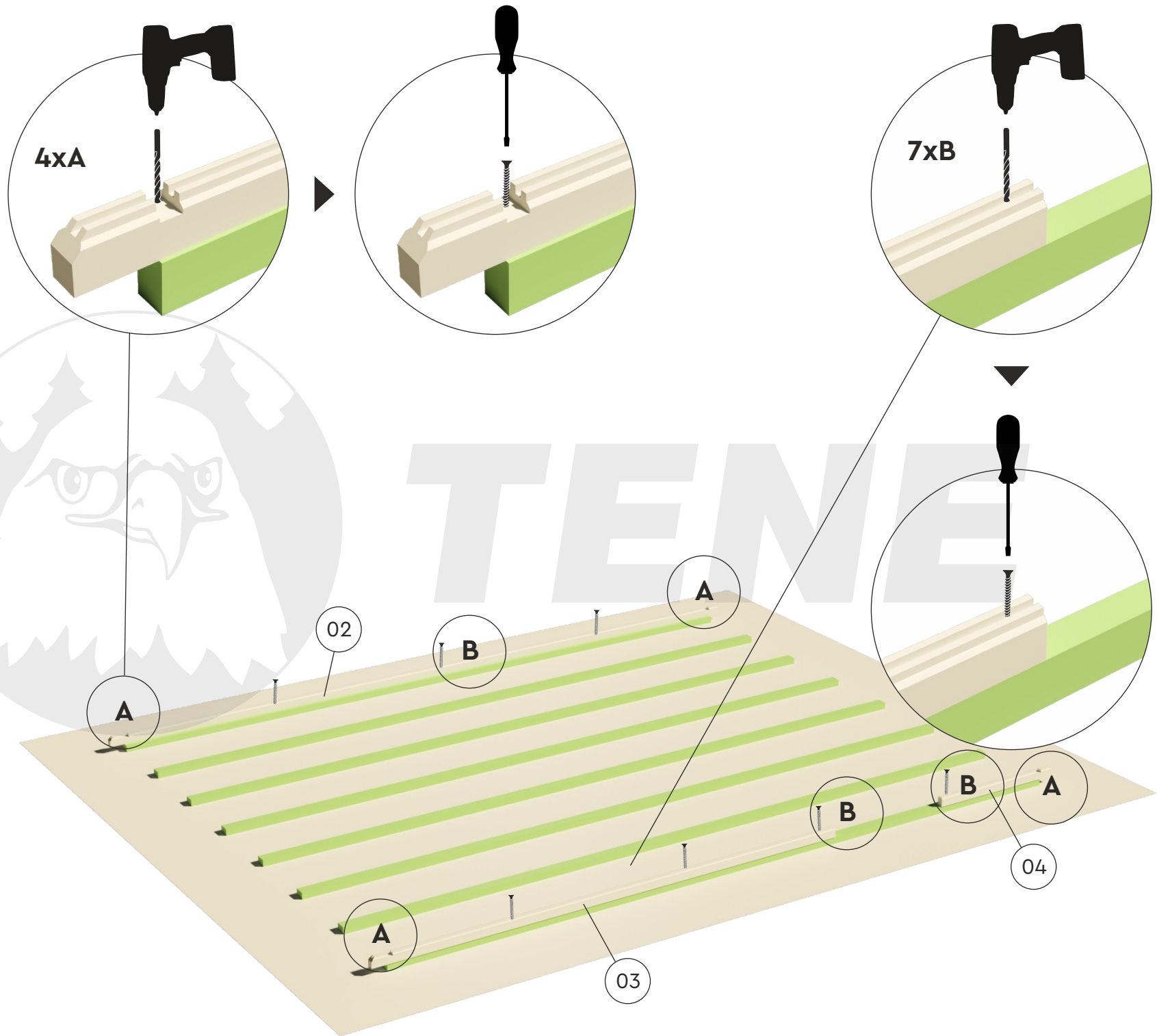
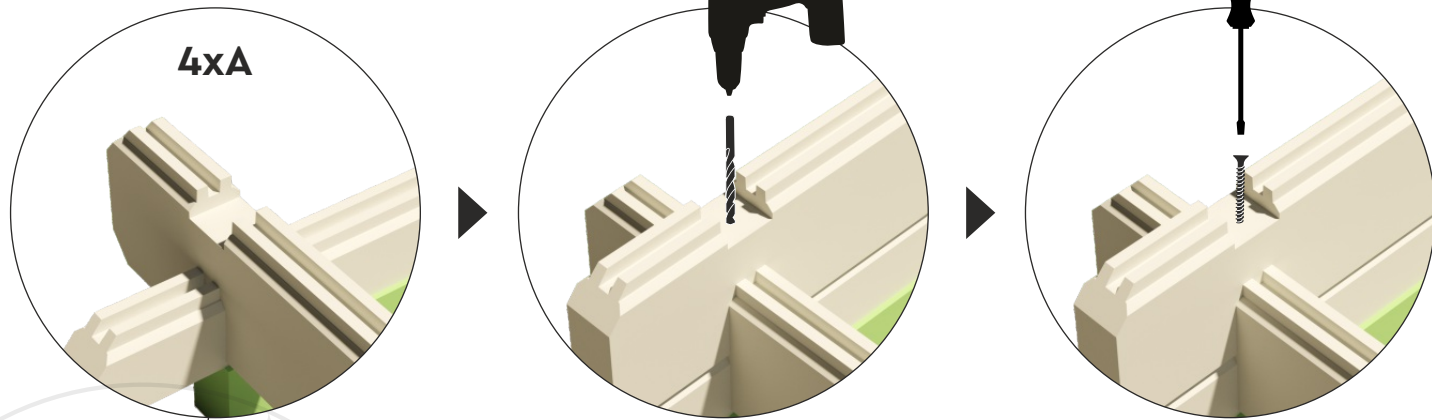

Ø 5 mm

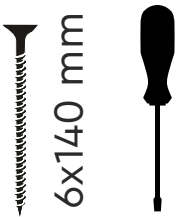

6x140 mm

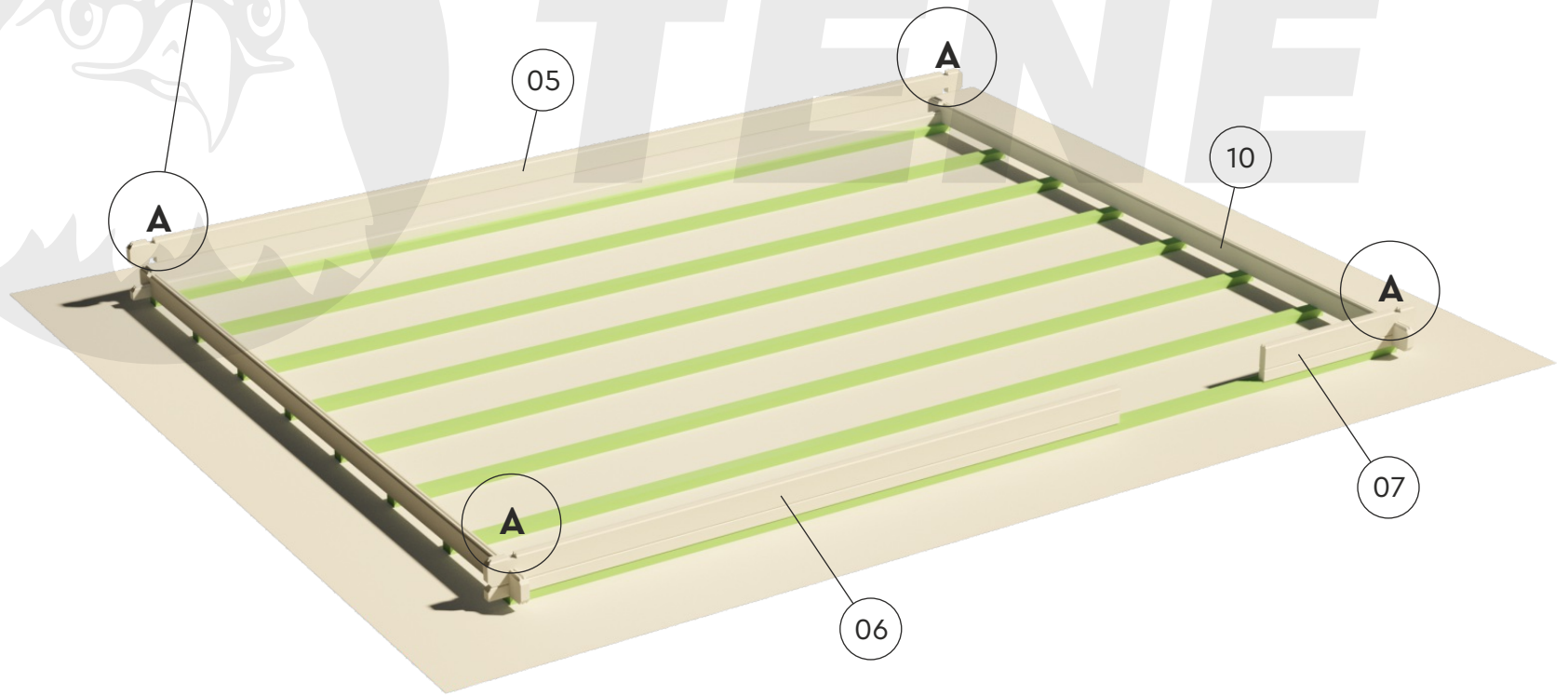
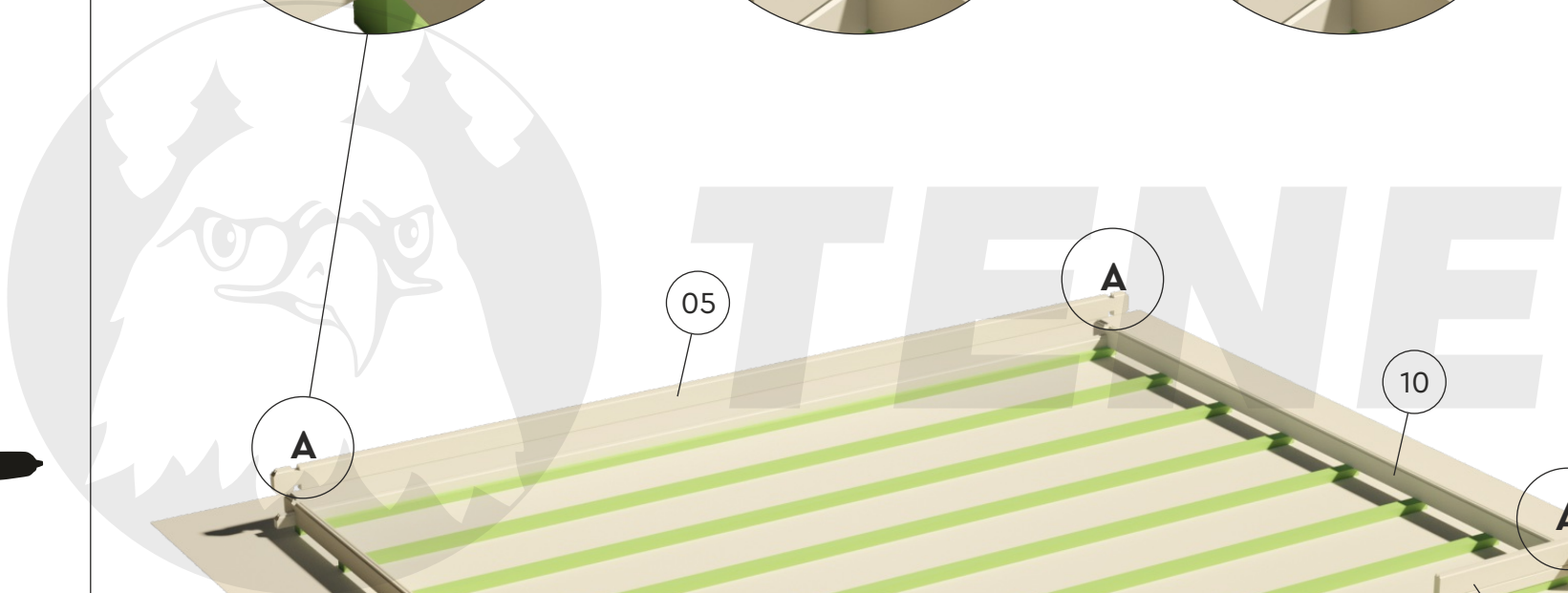

DANIEL 40

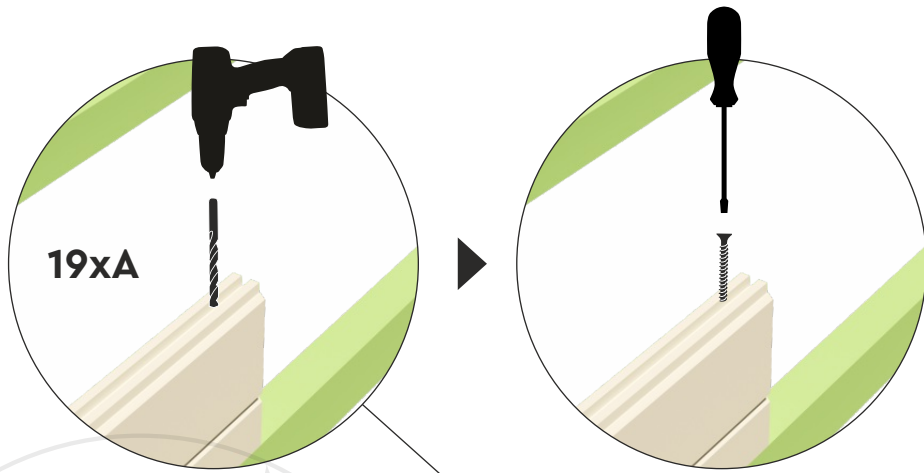

Ø 5 mm

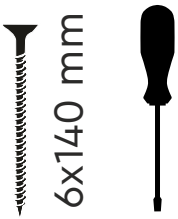

6x140 mm



TENE

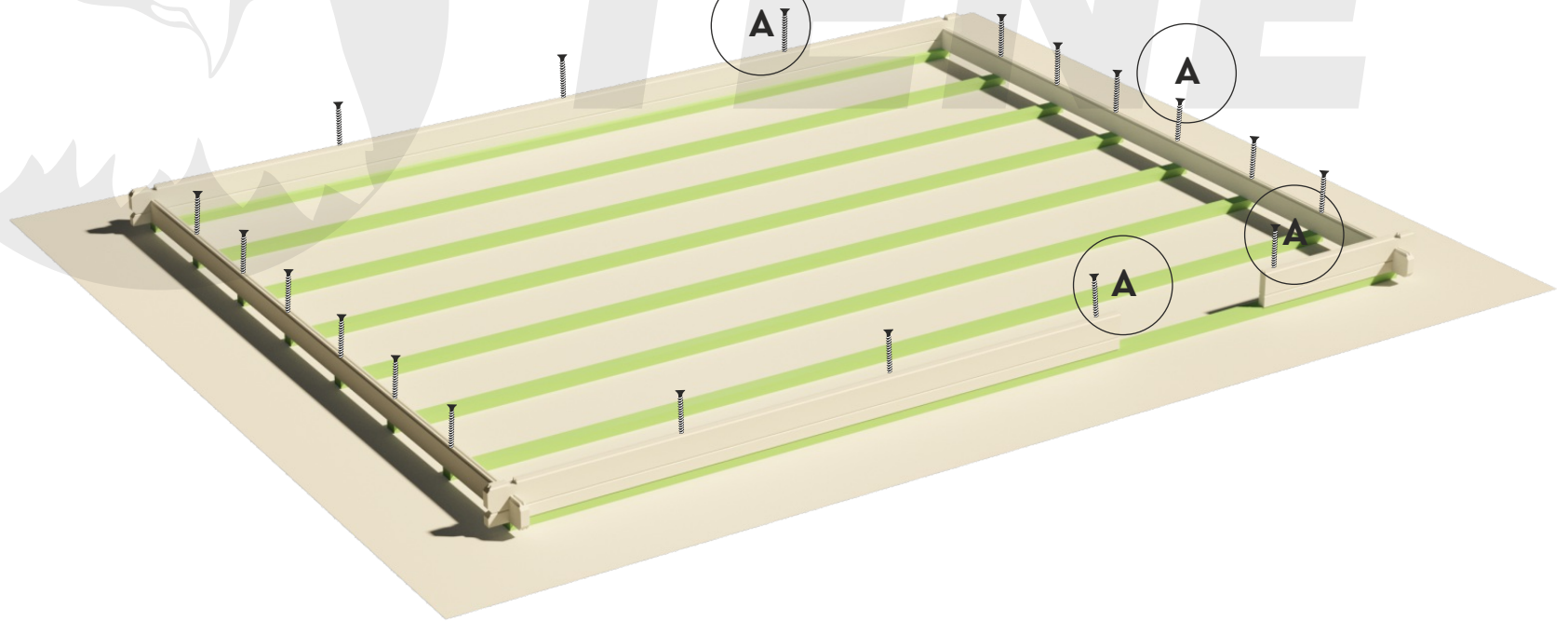

DANIEL 40

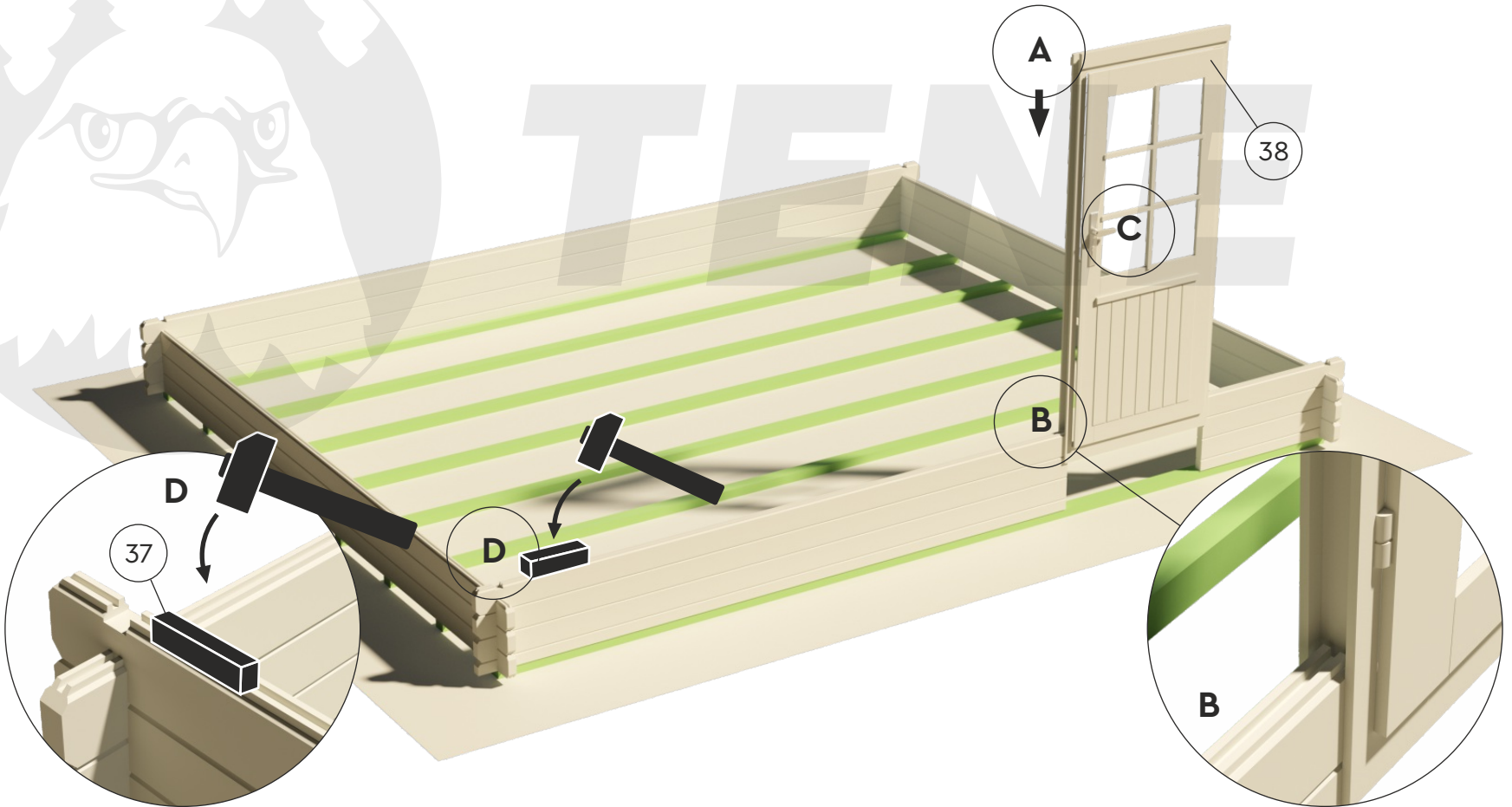
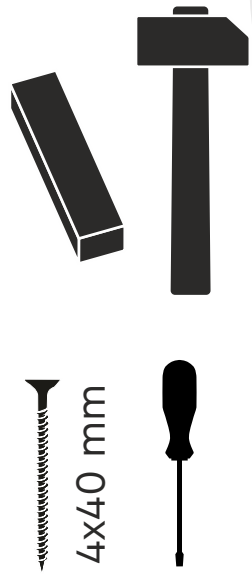
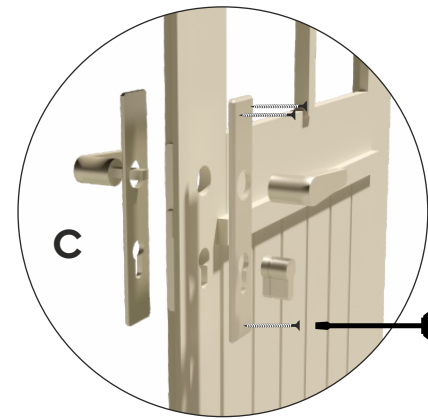
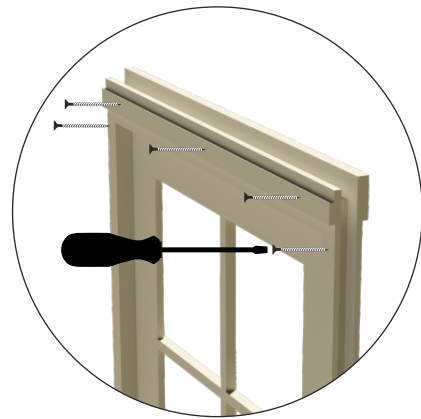
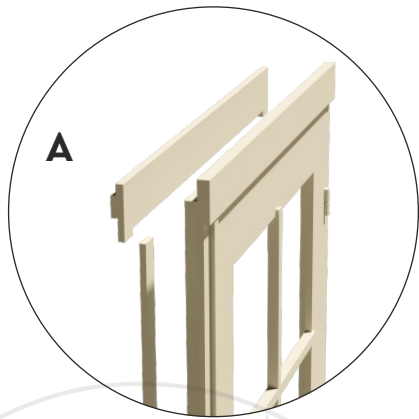

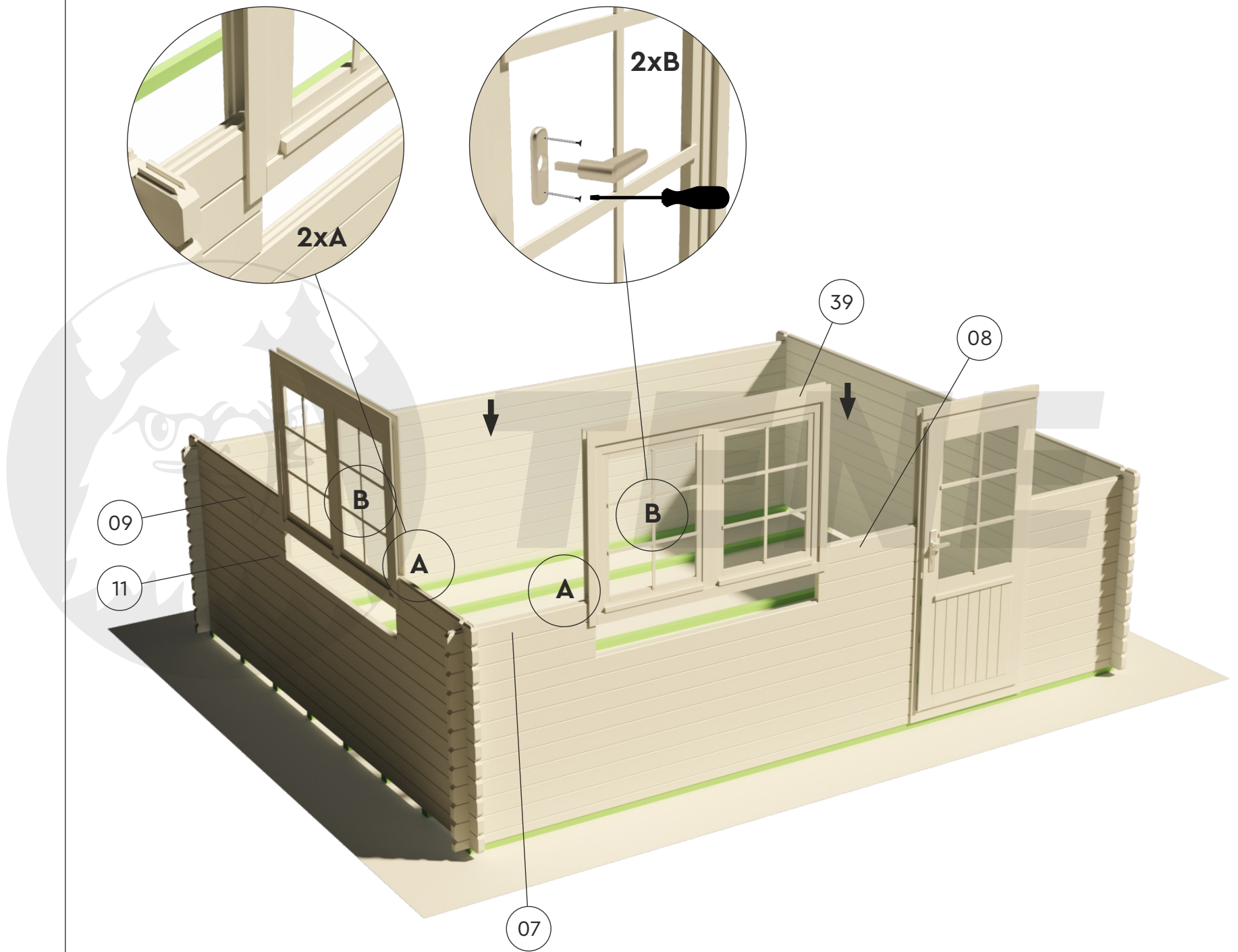

DANIEL 40

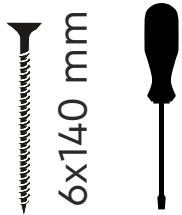
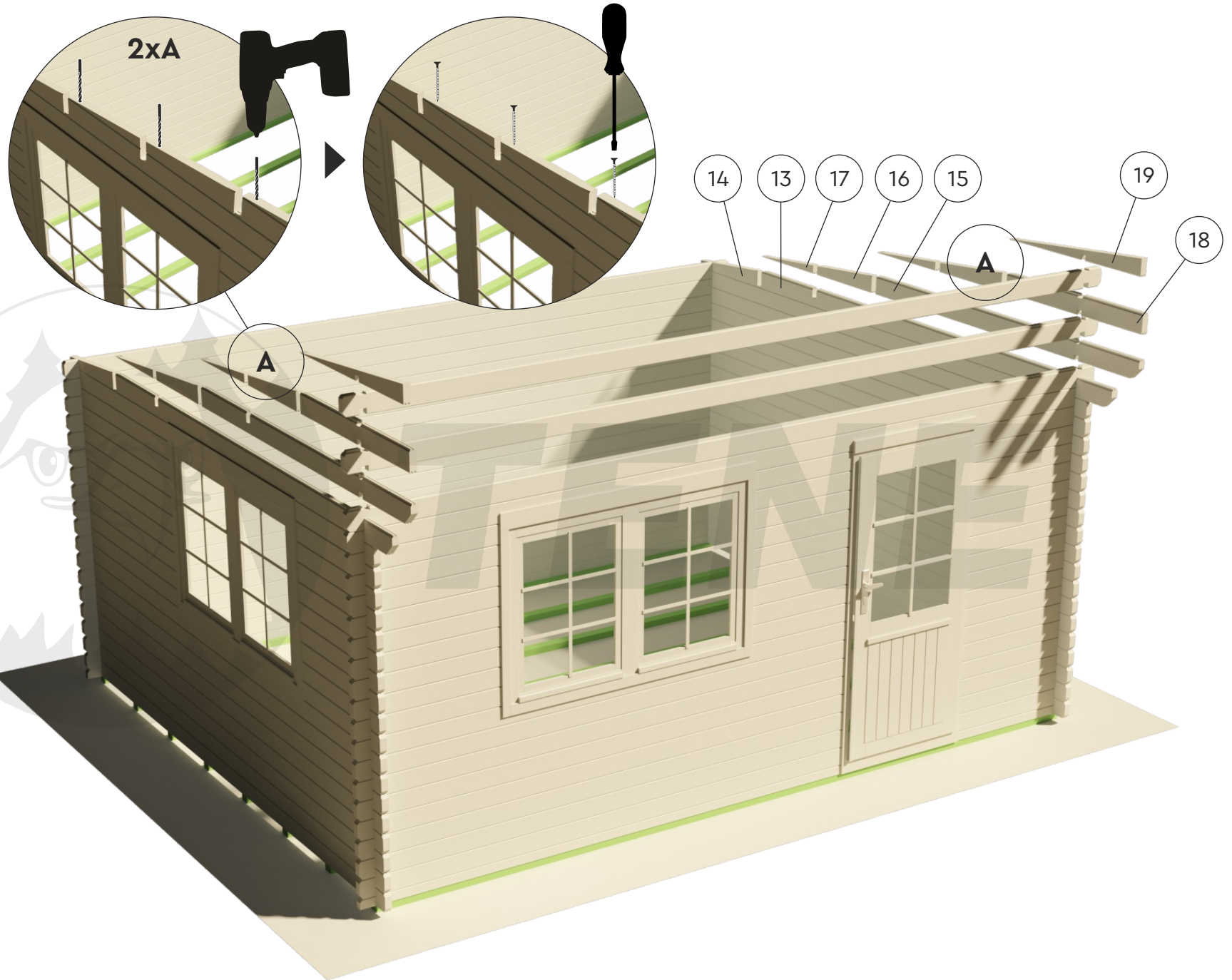

DANIEL 40

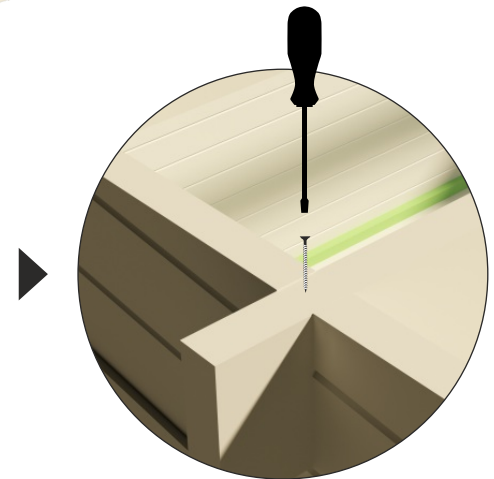
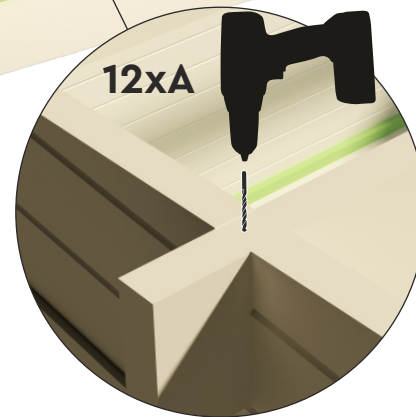
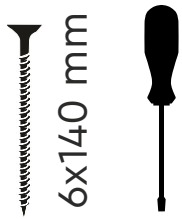
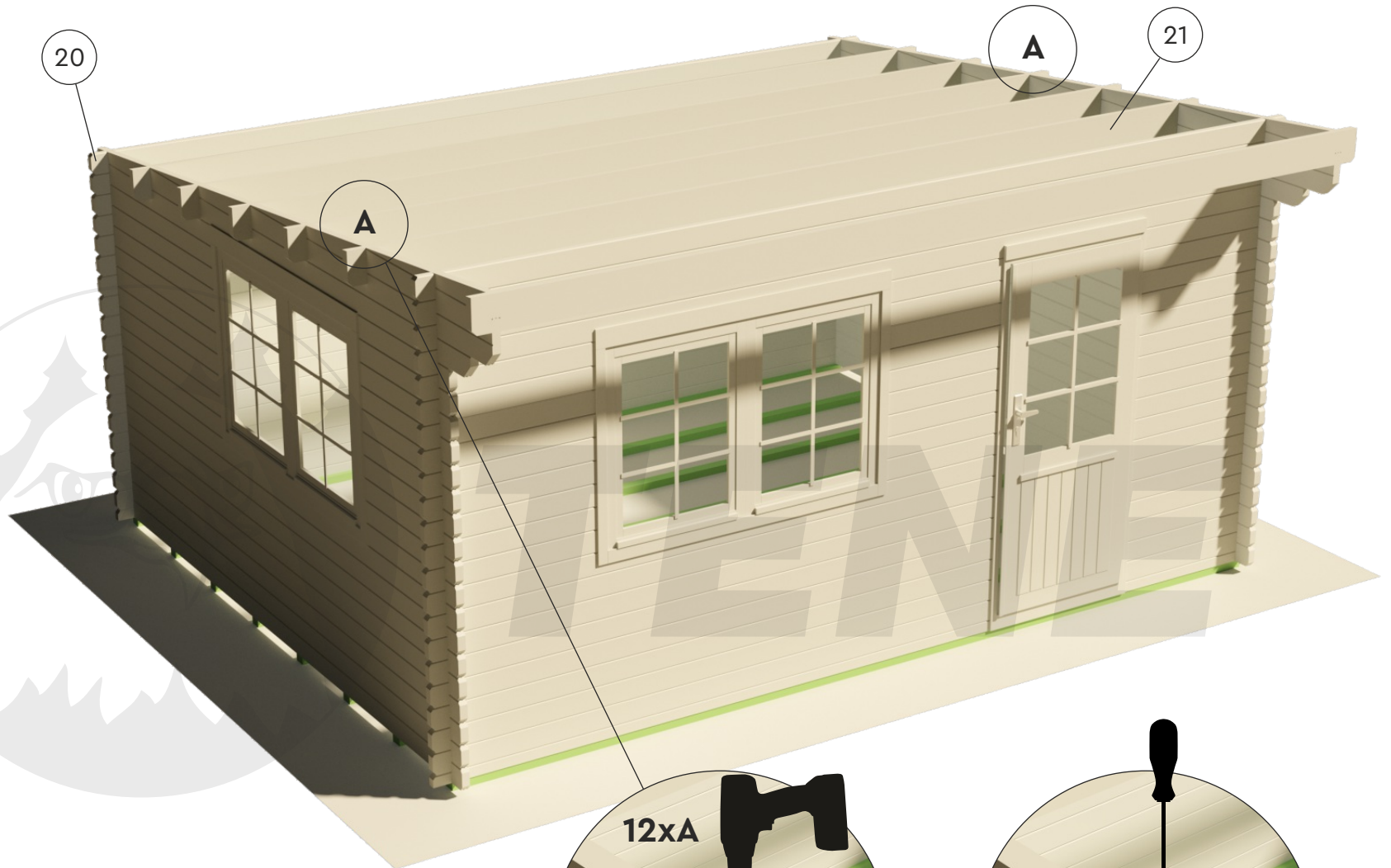

DANIEL 40

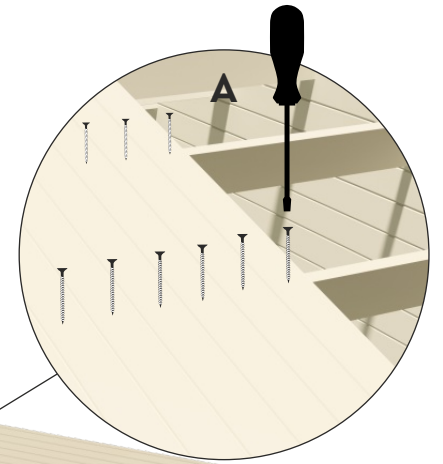
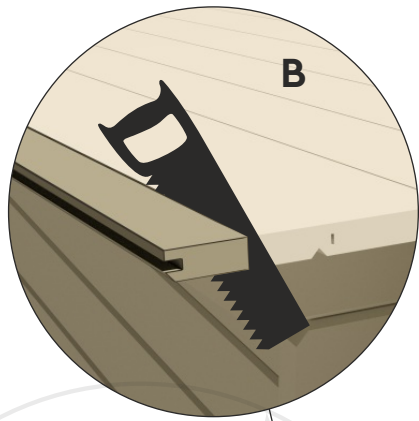

23

A

B



4x50 mm



DANIEL 40

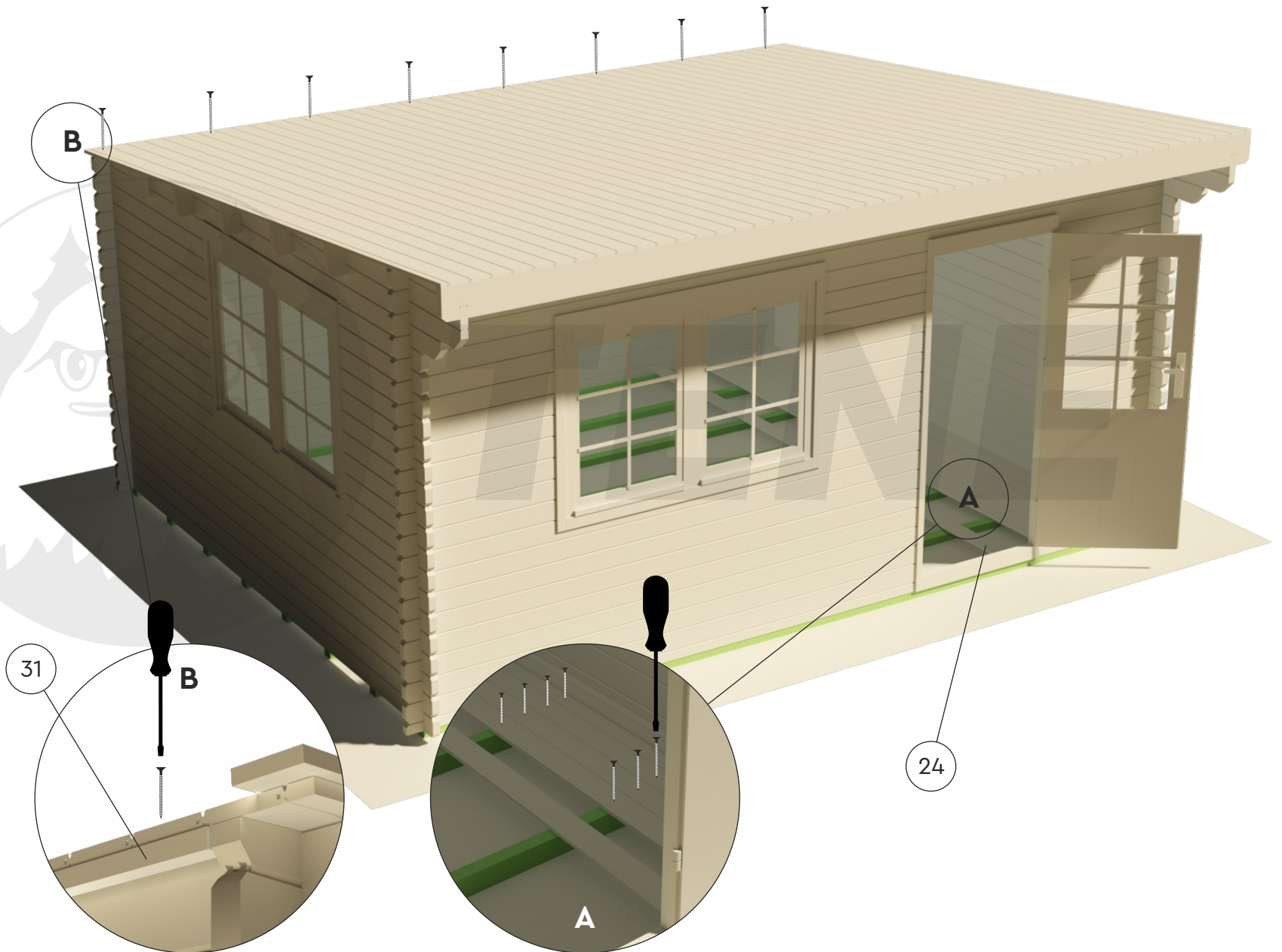
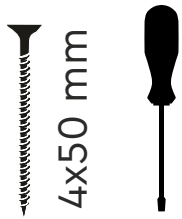

DANIEL 40

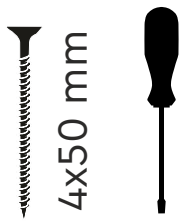
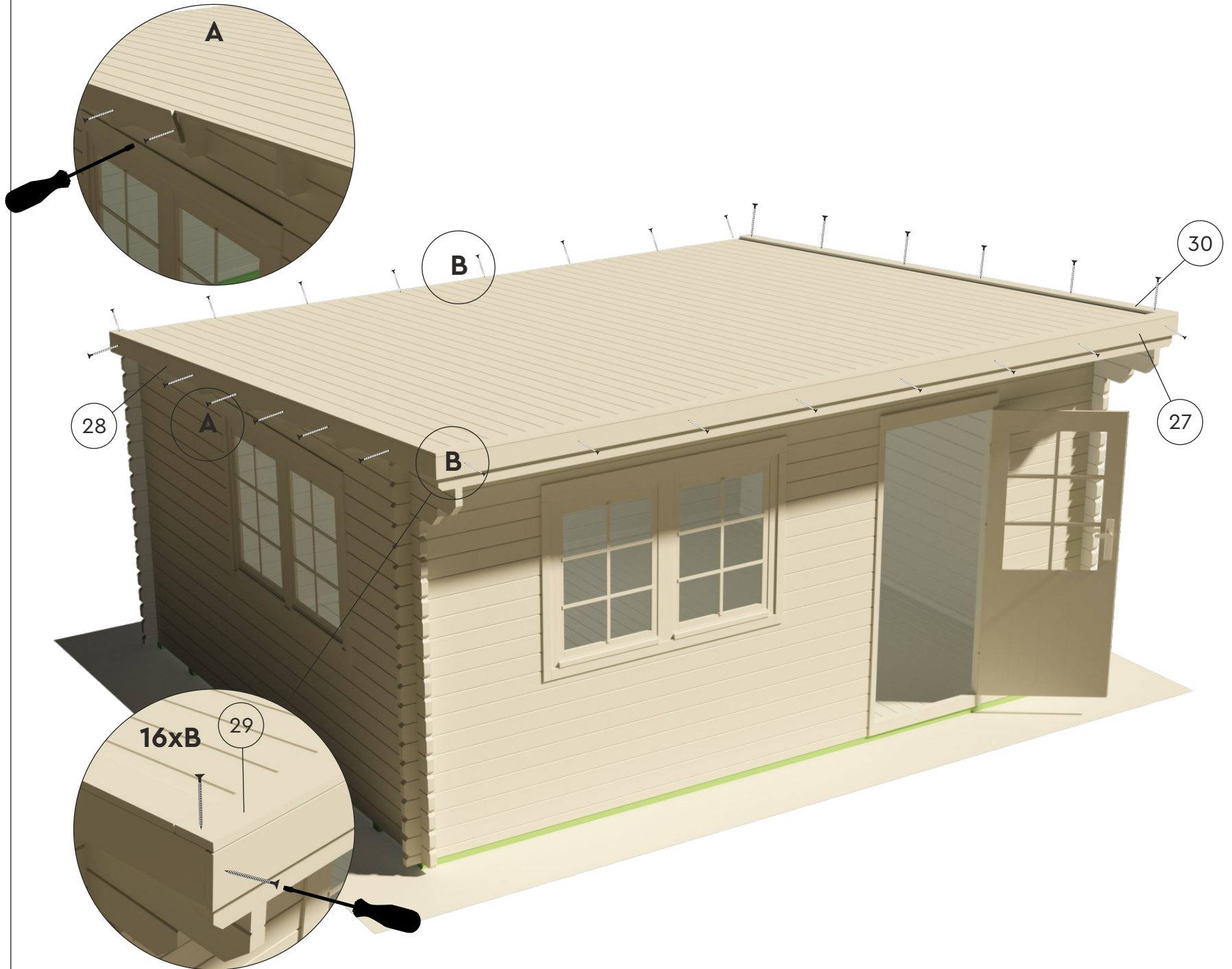

DANIEL 40

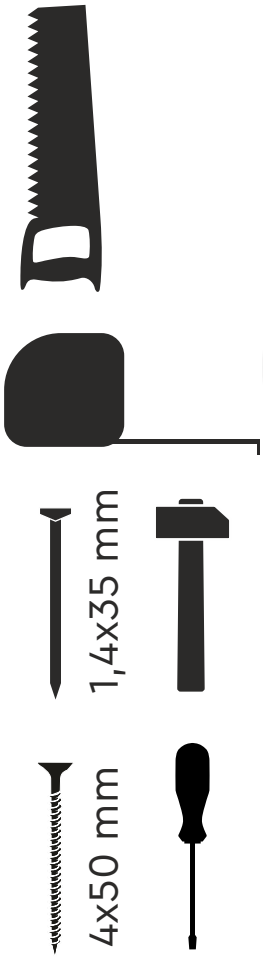

13/15

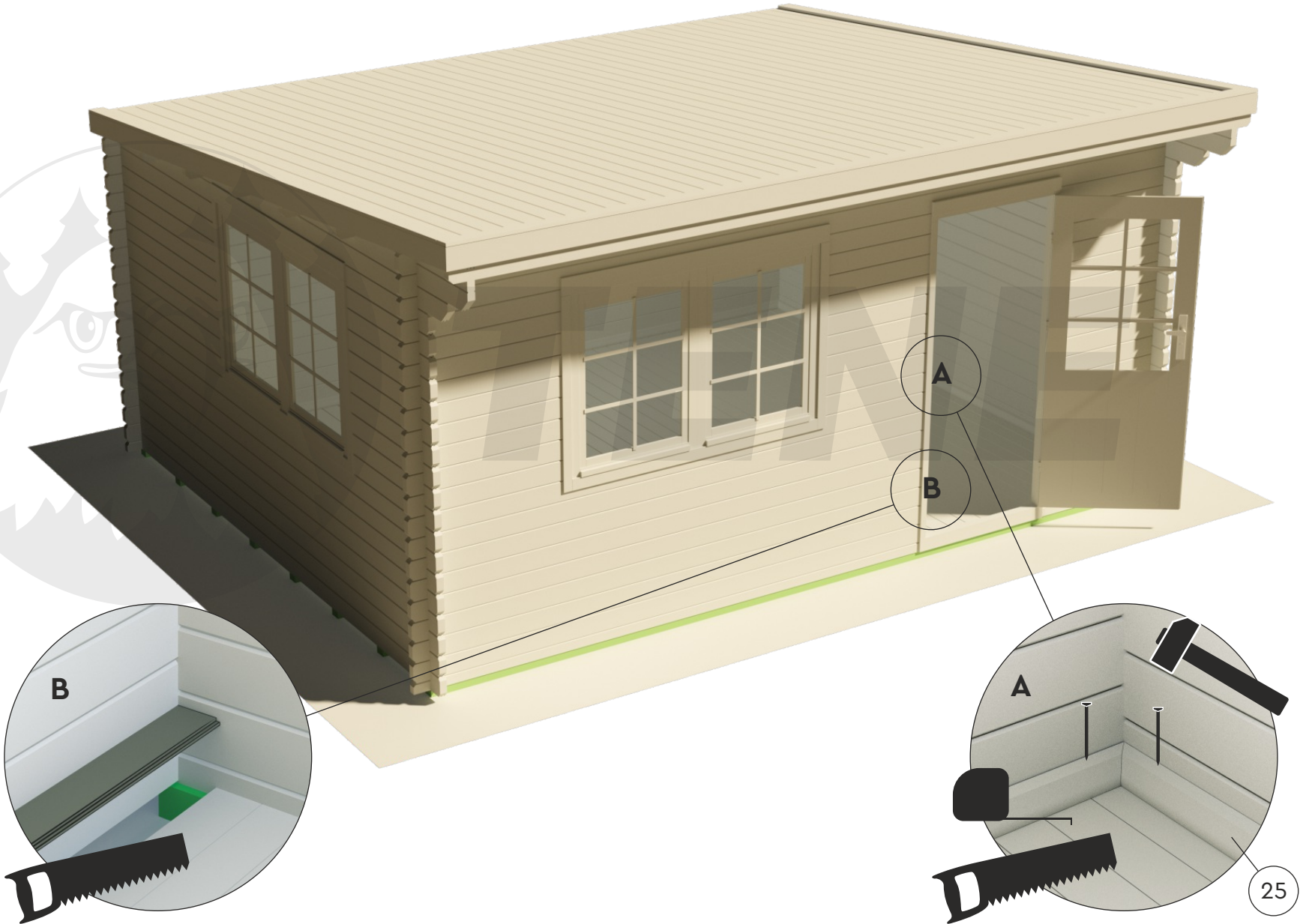

DANIEL 40

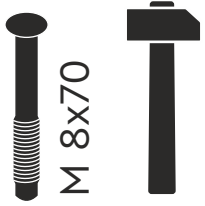
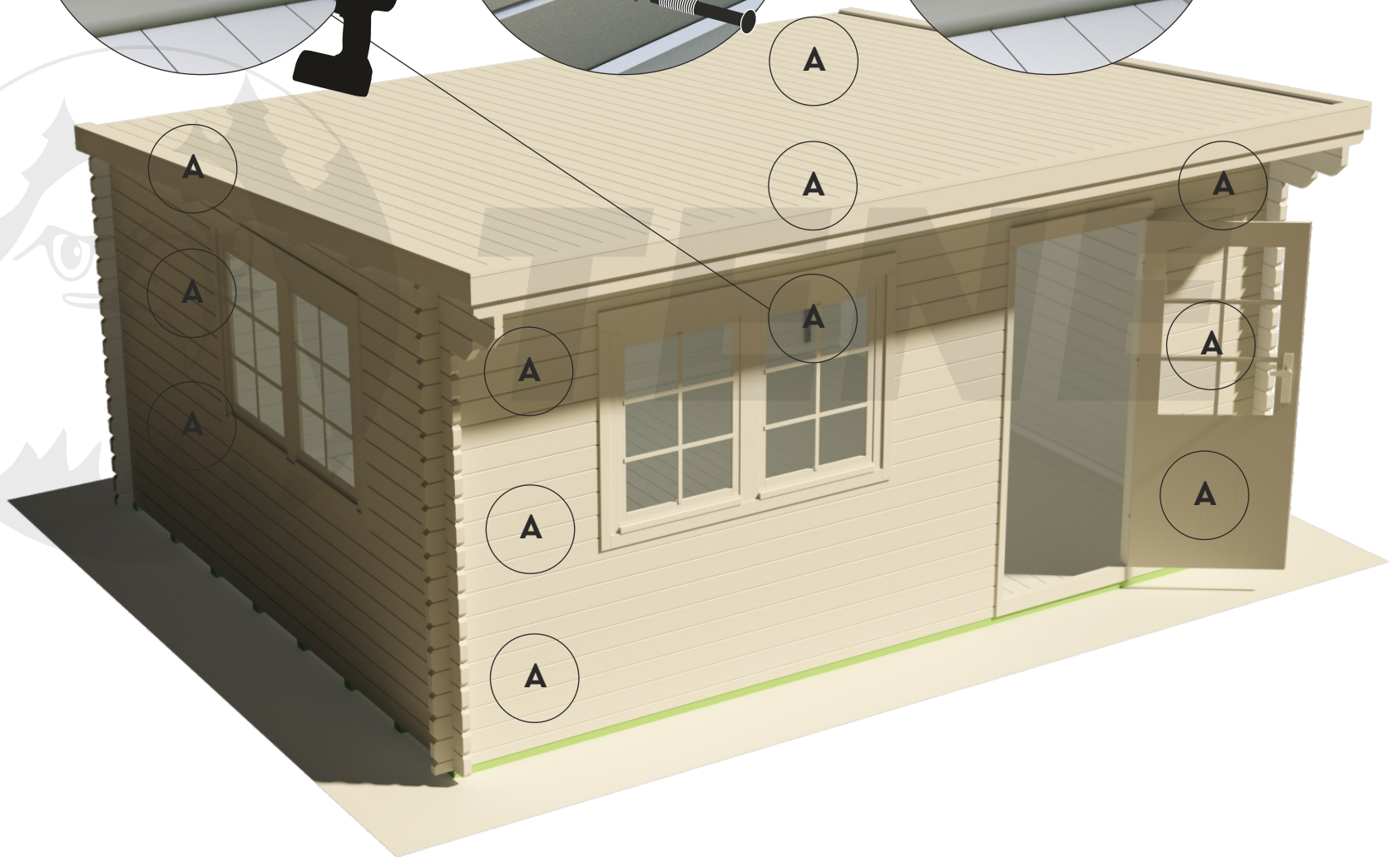
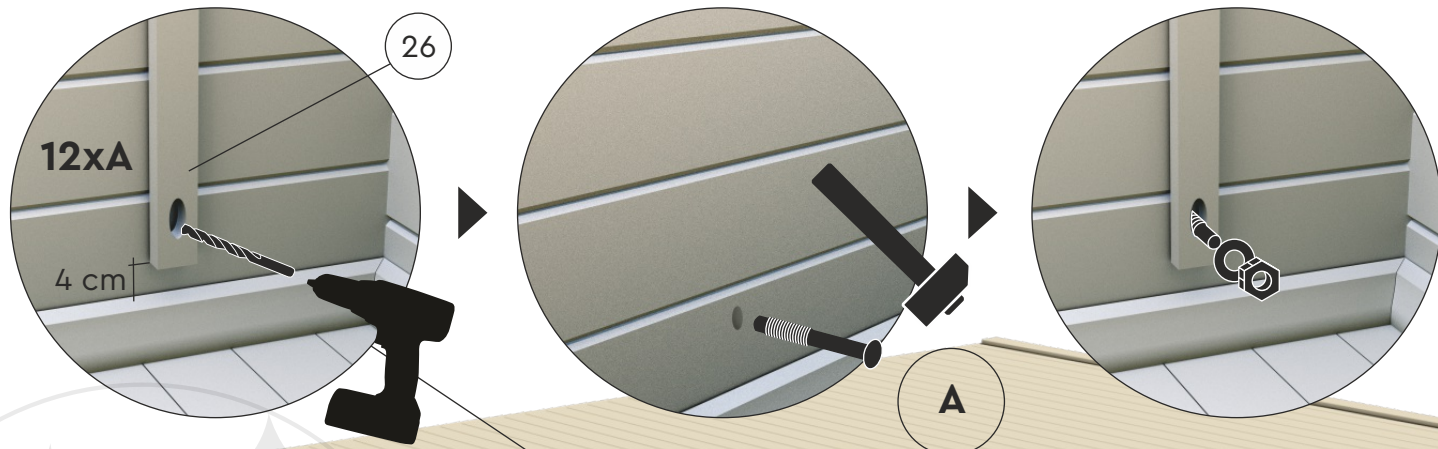

DANIEL 40

